



**OWNER'S
MANUAL
YETI ARC**



TABLE OF CONTENTS

BRAND OVERVIEW	03
FRAME FEATURES	05
GEOMETRY	07
MAINTENANCE SCHEDULE	09
<i>TECHNICAL</i>	
EXPLODED VIEWS	11
ASSEMBLY OVERVIEW	15
REBUILD KITS	19
<i>LEGAL</i>	
WARRANTY	23
CONTACT INFORMATION	24

CONGRATULATIONS ON YOUR PURCHASE OF A NEW YETI.

We are confident your new bicycle will exceed your expectations for value, performance, and ride quality. Each frameset and component has been custom specified and designed to enhance your riding experience. Whether you are a beginner cyclist, or a seasoned pro, your Yeti bicycle will provide endless hours of two-wheeled fun.

This model specific manual is designed to be used in conjunction with the general Yeti Owner's Manual and the manuals supplied by the suspension manufacturers. If you did not receive the Yeti owner's manual or the manual provided by the suspension manufacturer, download the materials off the Internet, or contact your local dealer.

Bicycling can be a hazardous activity even under the best of circumstances. Proper maintenance of your bicycle is your responsibility and when done properly helps reduce the risk of injury and damage to your bicycle.

Warning: Make sure you review and understand the warnings, instructions, and content of this manual and accompanying manuals for your bicycle.

Warning: Technological advances have made bicycles and bicycle components more complex and the pace of innovation is increasing. It is impossible for this manual or the accompanying manuals to provide all the information required to properly repair and/or maintain your bicycle. In order to help minimize the chances of an injury, it is critical for you to have work performed by an authorized Yeti retailer.

This manual outlines basic setup and maintenance recommendations of your new Yeti. Because it is impossible to anticipate every situation or condition that may occur during the assembly, setup, and maintenance of your bicycle, Yeti recommends that all service and repairs be performed by your local authorized Yeti Dealer.

This manual contains many "Warnings" and "Cautions" concerning the consequences of failure to maintain or inspect your bicycle. The word "Warning" indicates a potentially hazardous situation in which, if not avoided, could result in serious injury or death. The word "Caution" indicates a potentially hazardous situation in which, if not avoided may result in minor injuries or damage to your bicycle or a component of your bicycle. Be sure to read and understand all of the Warnings and Cautions listed in the manual.

THE LOWDOWN ON THE ARC AND ITS FEATURES.

1. MODERN GEO TO ELEVATE HOW HARDTAILS CAN BE RIDDEN
2. HIGH MODULUS CARBON FIBER MAIN FRAME AND SWING ARM
3. INTEGRATED 2-BOLT ISCG-05 MOUNTS
4. INTEGRATED 41MM / 52MM TAPERED HEADTUBE
5. CUSTOM DOWN TUBE PROTECTOR AND RIBBED CHAIN GUARDS TO DECREASE CHAIN SLAP NOISE
6. RATTLE-FREE CABLE PORT ASSEMBLY SECURES CABLES AND HOSES TO PROVIDE A SILENT RIDE
7. INTERNALLY MOLDED CARBON TUBES FOR HASSLE-FREE CABLE ROUTING AND A QUIET BIKE
8. INTEGRATED AXLE AND UNIVERSAL DERAILLEUR HANGER SYSTEM
9. BOOST HUB SPACING, FRONT AND REAR
10. DUAL WATERBOTTLE MOUNTING LOCATIONS
11. UNINTERRUPTED SEAT TUBE FOR COMPATIBILITY WITH LONGER TRAVEL DROPPER POSTS

1. Cutting-edge, high modulus carbon is hand laid to create our Turq Series frames. That same stiffness and efficiency can also be found in our Carbon Series frame sets.
2. The ARC does away with the front derailleur mount, making it a 1x drive specific frame.
3. 2-bolt ISCG-05 chain guide mounts are there for you in case you need extra drivetrain security for rowdy sections.
4. Designed around 130mm of travel, the ARC comes with the latest Fox Racing Shox 34 front fork.
5. Custom seatstay, chainstay and down tube guards keep the ride quiet while protecting the frame.
6. The ARC is designed with rattle-free cable ports and internally molded cable routing tubes keeping the bike quiet and clean looking while reducing cable rub and overall maintenance.
7. Configurable routing ports that provide a clean look to your frame when you ditch the cables and go wireless.
8. Dedicated 12 x 148 Boost dropouts with SRAM's universal derailleur hanger provide strength, stiffness and easy hanger and wheel installation.

GEOMETRY

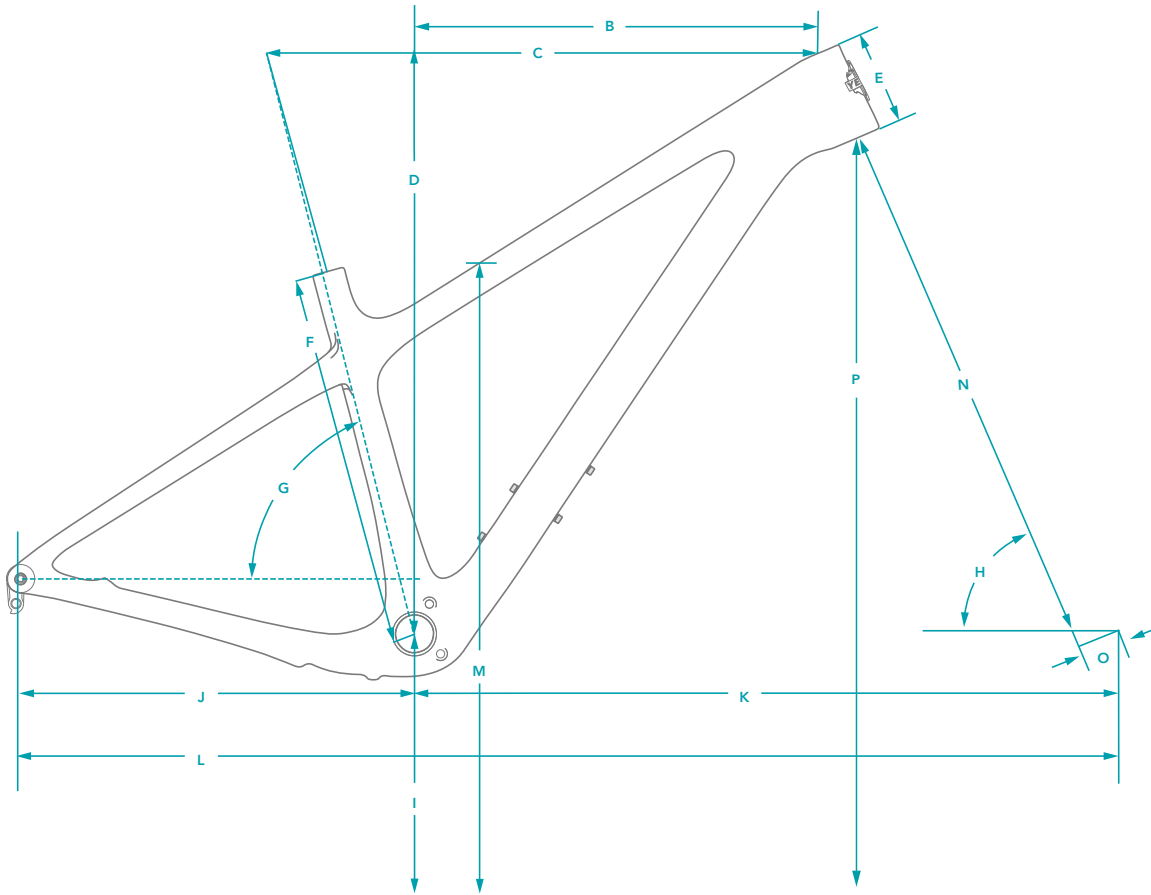

FOX 34 / 130MM FORK

	SM	MD	LG	XL
A WHEEL	29"	29"	29"	29"
B REACH	420.0	445.0	465.0	490.0
C EFF. TOP TUBE	577.4	604.3	626.0	653.4
D STACK	631.7	638.9	645.1	654.3
E HEAD TUBE LENGTH	95.0	102.9	109.6	119.6
F SEAT TUBE LENGTH	380.0	410.0	450.0	495.0
G EFF. SEAT TUBE ANGLE	76.0	76.0	76.0	76.0
H HEAD TUBE ANGLE	67.0	67.0	67.0	67.0
I EST. BB HEIGHT	310.0	310.0	310.0	310.0
J CHAINSTAY LENGTH	433.0	433.0	433.0	433.0
K FRONT-CENTER	710.5	738.5	761.2	790.1
L WHEELBASE	1143.5	1171.5	1194.2	1223.1
M STANDOVER	723.0	722.0	720.0	720.0
N ALXE TO CROWN	543.7	543.7	543.7	543.7
O FORK OFFSET	44	44	44	44
P VERTICAL WHEEL TRAVEL	119.7	119.7	119.7	119.7

*All measurements are in millimeters

FIT

SMALL	5'1" (155 CM) - 5'7" (170 CM)
MEDIUM	5'5" (165 CM) - 5'11" (180 CM)
LARGE	5'10" (178 CM) - 6'3" (191 CM)
X-LARGE	6'1" (185 CM) - 6'7" (200 CM)

KEEP YOUR YETI FRESH AND CLEAN

OVERVIEW

Following these guidelines will help maintain the performance of your bicycle and prevent more serious problems from arising. It is important to remember that service intervals can vary depending on climate, trail conditions and riding frequency. If you are unsure about working on your own bicycle, contact your authorized Yeti Dealer for more information on general bicycle maintenance.

SCHEDULE	WEEKLY	MONTHLY	3 MONTHS	ANNUALLY
CLEAN AND LUBE CHAIN	■			
CHECK TIRE PRESSURE	■			
CLEAN BIKE OF MUD AND DEBRIS	■			
CHECK BRAKE FUNCTION	■			
CHECK FOR LOOSE BOLTS AND TIGHTEN, IF NECESSARY		■		
CHECK HEADSET AND TIGHTEN / LOOSEN, IF NECESSARY		■		
CHECK / REPLACE BRAKE PADS			■	
CHECK TIRES FOR WEAR			■	
CHECK SPOKE TENSION. RETENTION, IF NECESSARY			■	
CHECK CHAIN FOR WEAR. REPLACE IF NECESSARY			■	
COMPLETE TUNE-UP PERFORMED BY AN AUTHORIZED YETI DEALER				■

TORQUE

Yeti strongly recommends using a torque wrench when assembling your frame. Torque specifications for individual parts on the ARC are listed below, as well as in the step by step assembly instructions later in the manual. For general bicycle maintenance please consult the torque specifications of the component you are adjusting.

KEY TORQUE SPECS

PART NUMBER	DESCRIPTION	TORQUE (NM)
300030010	SHCS, M5 X 0.8, 16L	4-5
300030177	SCREW, FH, M4 X 0.7, 25L	2-3
300030174	SCREW, FH, M4 X 0.7, 15L	3
300030173	SCREW, FH, M4 X 0.7, 10L	2-3
300030162	UNIVERSAL HANGER STOPPER	5
300060080	SRAM UNIVERSAL HANGER	25

EXPLODED VIEW

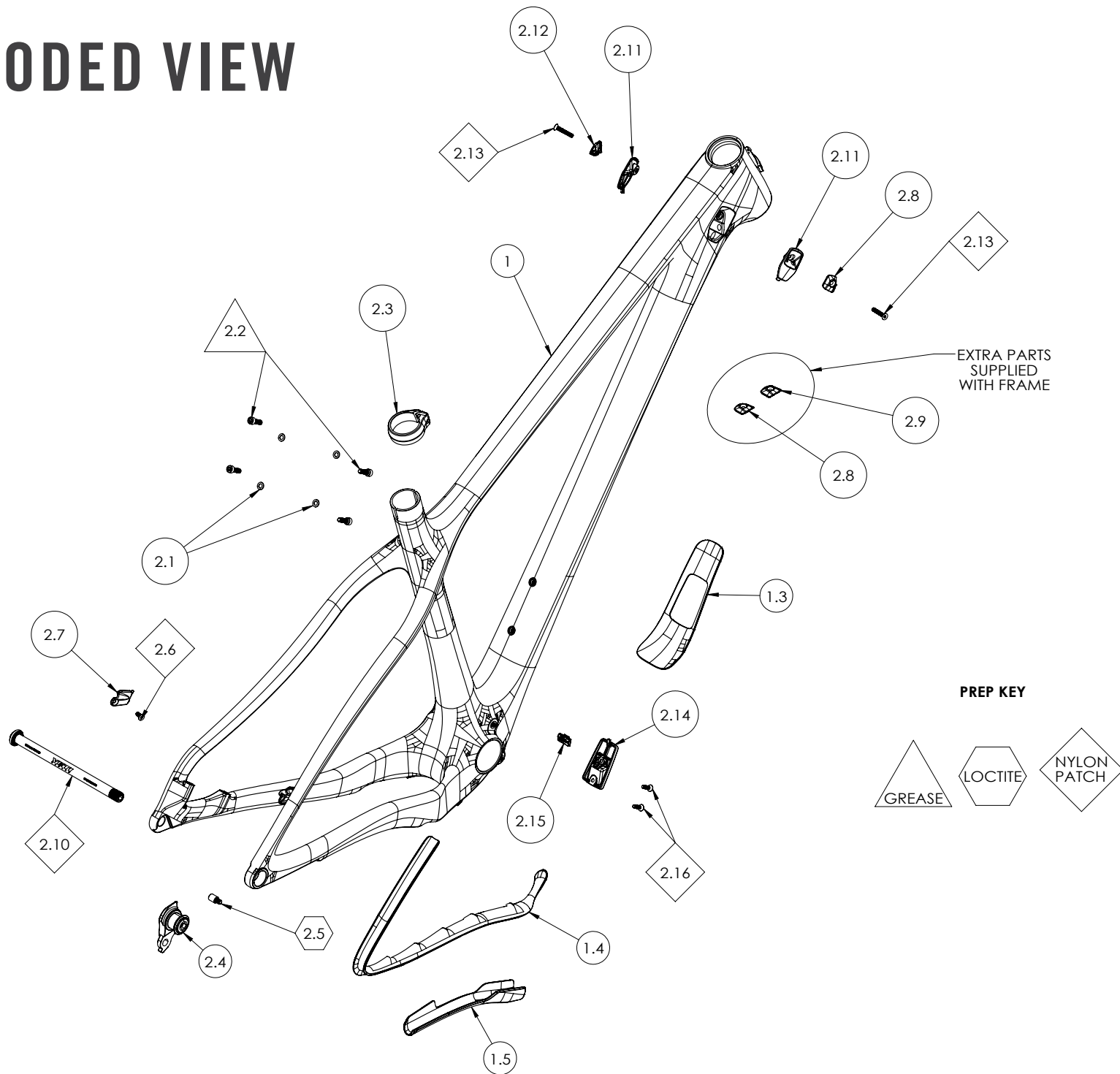

EXPLODED VIEW PARTS LIST

ITEM#	PART #	DESCRIPTION	QTY
1	N/A	ARC FRAME ASSEMBLY	1
1.3	400100209	DOWN TUBE GUARD, ARC	1
1.4	400100210	CS/SS PROTCTOR, ARC	1
1.5	400100211	CS LOWER PROTECTOR, ARC	1
2	N/A	HARDTAIL ASSEMBLY PARTS	1
2.1	300030148	WASHER 5.1 X 8.9 X 1.0 MM	4
2.2	300030010	SHCS, M5 X 0.8, 16L	4
2.3	300060078	ASSEMBLY, YETI SEAT CLAMP, BOLT ON, 31.6	1
2.4	300060080	SRAM UNIVERSAL HANGER	1
2.5	300030162	UNIVERSAL HANGER STOPPER	1
2.6	300030173	SCREW, FH, M4 X 0.7, 10L	1
2.7	300040518	COVER-CABLE PORT, SINGLE, RIGHT EXIT	1
2.8	300040521	CLAMP, HT PORT SINGLE, PA6	2
2.9	300040523	COVER, HT PORT, BLIND, PA6	1
2.10	100425009	AXLE, M12X1 X 174L, BOLT-ON, BLACK	1
2.11	300040524	CABLE PORT COVER, HEAD TUBE, 2 PIECE	2
2.12	300040522	CLAMP, HT PORT DOUBLE, PA6	1
2.13	300030177	SCREW, FH, M4 X 0.7, 25L	2
2.14	300040519	CABLE PORT COVER, DOWN TUBE	1
2.15	300040514	CLAMP-LOWER PORT	1
2.16	300030174	SCREW, FH, M4 X 0.7, 15L	2

FRAME ASSEMBLY

YETI TIPS

Make sure your tools are in good condition. A worn allen key can round the hex on a bolt not allowing for proper torque.

Torque settings are listed throughout the instructions and on page 10 of this manual. It is important to prep all bolt threads. The instructions denote whether to use a Loctite compound or grease. Reference Exploded View for assembly part locations listed in parentheses.

Warning: Service on Yeti bicycles requires special knowledge and tools. Yeti Cycles recommends that all service and repairs be performed by an authorized Yeti Dealer

TOOLS NEEDED

- 2.5mm allen key
- 4mm allen key
- 8mm allen key
- Torque wrench

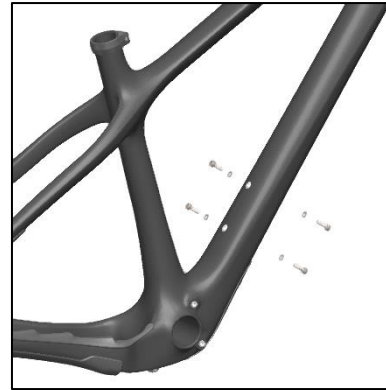

01. Grease 4x H20 Bolts (2.2) and install with washers (2.1) to frame downtube.

Torque: 4-5 Nm



02 Place a Head Tube Cable Port Cover (2.11) into each recess behind the head tube.



03 Place a Double Port Clamp (2.12) into the non-drive side cover and a Single Port Clamp (2.11) into the drive-side cover. Secure with M4 x 25L screws.

Tighten until snug. Hardware can be torqued to **2-3 Nm** after housing installation.

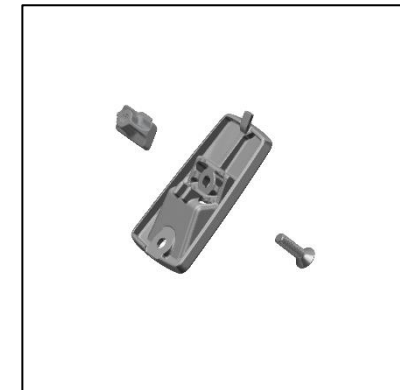

04 Assemble a Lower Port Clamp (2.15) to the Down Tube Port Cover (2.14) using a Flat Head M4 x 16L screw. Hardware can be torqued to **2-3 Nm** after housing installation.



ASSEMBLY



05

Install the Down Tube Port Cover (2.14) into the frame with a Flat Head M4 x 16L screw (2.16).

Torque: 3 Nm

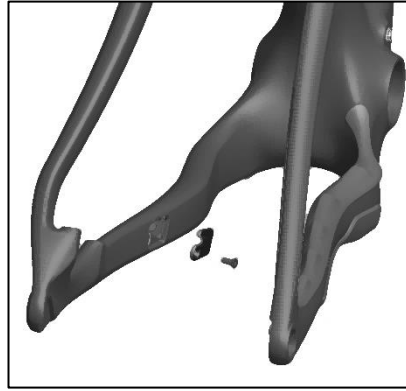

06

Install the Chainstay Cable Port Cover (2.7) to the non-drive side chainstay port and secure with Flat Head M4 x 10L.

Hardware can be torqued to **2-3 Nm** after housing installation.

09

Note that different Port Clamps may be used for different configurations of shifter and dropper seatpost. An extra single-port and blank cover are provided depending on your needs.

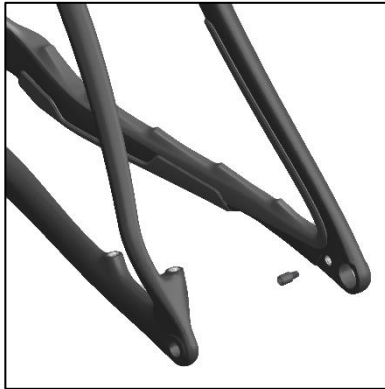

07

Apply Blue Loctite 243 to threads of the Hanger Stop Bolt (2.5).

Install Stop Bolt into rear dropout.

Torque: 5 Nm

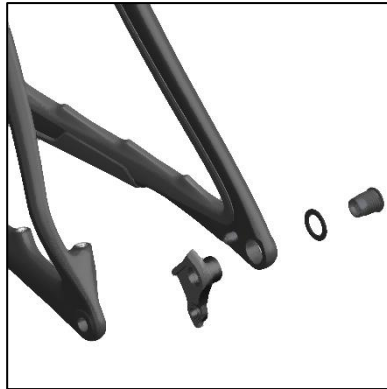

08

Install Universal Hanger (2.4) into frame. Do not use grease. Note that hanger cap bolt is REVERSE THREADED.

Torque: 25 Nm

FRAME ASSEMBLY IS COMPLETE

REBUILD KITS

PART #	DESCRIPTION	QTY
200020368	ARC MASTER REBUILD KIT	
300030162	STOP BOLT, UNI HANGER	1
300030173	CAP SCREW, FH, M4 x 0.7, 10L	1
300030174	CAP SCREW, FH, M4 x 0.7, 16L	2
300030177	CAP SCREW, FH, M4 x 0.7, 25L	2
300040514	CLAMP, DT CABLE PORT	1
300040518	CABLE PORT COVER, REAR CHANSTAY	1
300040519	CABLE PORT COVER, DOWN TUBE	1
300040521	CLAMP, HT PORT, SINGLE	2
300040522	CLAMP, HT PORT, DOUBLE	1
300040523	COVER, HT, NO PORT	1
300040524	CABLE PORT COVER, HT	2
400100213	ARC PROTECTOR KIT	
400100211	CS LOWER PROTECTOR, ARC	1
400100210	CS/SS PROTCTOR, ARC	1
400100209	DT GUARD, ARC	1

PART #	DESCRIPTION	QTY
	HANGER	
300060080	SRAM UNIVERSAL HANGER, 20190506	1
	AXLE	
100425009	REAR AXLE 148x12 UDH BLACK	1

FOX TRANSFER POST INSERTION GUIDE

MEASURE FROM TOP OF SEAT TUBE TO BOTTOM OF DROPPER POST AS SHOWN BELOW (MEASUREMENTS IN MM)

		FOX TRANSFER POST SIZE		
		125	150	175
FRAME SIZE	SM	228	258	290
	MD	228	258	290
	LG	228	258	290
	XL	228	258	290

MAX INSERTION (X)

NOTE: Saddle centered on straight length of rails.

LIFETIME WARRANTY

HERE'S EVERYTHING YOU NEED TO KNOW ABOUT OUR LIFETIME WARRANTY:

All 2019 (or newer) frames, including the Switch Infinity, are covered for life against damage due to manufacturing defects for the original purchaser. Paint and finish are covered for 1-year. We will repair or replace, at our discretion, any frame we deem defective. There are a few conditions: you must register it online at yeticycles.com and you must take it to an authorized Yeti Cycles dealer for processing. Warranty does not cover damage due to ordinary wear and tear, neglect or intentional destruction. From a slingshot or your truck.

If you happen to have a crash or non-warranty situation, we'll get you back on the trail with a reasonable replacement price. Same conditions as above.

Lifetime Warranty applies to all 2019 and newer frames (including the SB100). Model year 2018 and older frames will be covered under our previous warranty (5-year or 2-year based on time of purchase).

Simple as that. No fine print.

DISCLAIMER

YETI Cycles is not responsible for any damages to you or others arising from riding, transporting or other use of your bicycle. In the event that your frame breaks or malfunctions, YETI Cycles shall have no liability or obligation beyond the repair or replacement of your frame pursuant to the terms outlined in the warranty.

**If you have a warranty concern, please contact your authorized Yeti dealer.*

YETI CYCLES

621 Corporate Circle, Unit
B Golden, CO 80401
(p) 303-278-6909
(f) 303-278-6906
www.yeticycles.com

BUSINESS HOURS

Monday-Friday
8AM-11:30AM,
1:00PM-5:30PM (Mountain
Time)