

OWNER'S MANUAL

2015 YETI SB6C



TABLE OF CONTENTS

BRAND OVERVIEW	06
FRAME FEATURES	08
GEOMETRY	10
MAINTENANCE SCHEDULE	12
<i>SETUP</i>	
OVERVIEW	12
SHOCK SETUP	14
DERAILLEUR HANGER INSTALL	16
CABLE/LINE SETUP	18
<i>TECHNICAL</i>	
ASSEMBLY OVERVIEW	20
EXPLODED VIEWS	26
REBUILD KITS	38
<i>LEGAL</i>	
WARRANTY	30
CONTACT INFORMATION	31

CONGRATULATIONS ON YOUR PURCHASE OF A NEW YETI.

We are confident your new bicycle will exceed your expectations for value, performance, and ride quality. Each frameset and component has been custom specified and designed to enhance your riding experience. Whether you are a beginner cyclist, or a seasoned pro, your Yeti bicycle will provide endless hours of two-wheeled fun.

This model specific manual is designed to be used in conjunction with the general Yeti Owner's Manual and the manuals supplied by the suspension manufactures. If you did not receive the Yeti owner's manual or the manual provided by the suspension manufacturer download the materials off the Internet, or contact your local dealer.

Bicycling can be a hazardous activity even under the best of circumstances. Proper maintenance of your bicycle is your responsibility and when done properly helps reduce the risk of injury and damage to your bicycle.

Warning: Make sure you review and understand the warnings, instructions, and content of this manual and accompanying manuals for your bicycle.

Warning: Technological advances have made bicycles and bicycle components more complex and the pace of innovation is increasing. It is impossible for this manual or the accompanying manuals to provide all the information required to properly repair and/or maintain your bicycle. In order to help minimize the chances of an injury, it is critical for you to have work performed by an authorized Yeti retailer.

This manual outlines basic setup and maintenance recommendations of your new Yeti. Because it is impossible to anticipate every situation or condition that may occur during the assembly, setup, and maintenance of your bicycle, Yeti recommends that all service and repairs be performed by your local authorized Yeti Dealer.

This manual contains many "Warnings" and "Cautions" concerning the consequences of failure to maintain or inspect your bicycle. The word "Warning" indicates a potentially hazardous situation in which, if not avoided, could result in serious injury or death. The word "Caution" indicates a potentially hazardous situation in which, if not avoided may result in minor injuries or damage to your bicycle or a component of your bicycle. Be sure to read and understand all of the Warnings and Cautions listed in the manual.

THE LOWDOWN ON THE SB6c AND ITS FEATURES.

1. SWITCH INFINITY TECHNOLOGY PATENTED SUSPENSION SYSTEM
2. HIGH MODULUS CARBON FIBER MAIN FRAME AND SWING ARM
3. OVERSIZED PIVOT PINS WITH ENDURO MAX BEARINGS
4. INTEGRATED ISCG 05 MOUNTS
5. TAPERED INSET HEAD TUBE (44MM/56MM)
6. SUSPENSION BY FOX (8.5 X 2.5)
7. CUSTOM CHAIN-SLAP GUARDS
8. INTERNALLY ROUTED CABLES
9. DIRECT MOUNT FOR SHIMANO SIDE SWING FRONT DERAILLEUR
10. DEDICATED BOOST 12 X 148 DROPOUTS

1. The SB6c delivers 6 inches (157mm) of travel with our patented Switch Infinity Technology. Efficient pedaling performance while still smooth and continuous when the going gets rough.
2. High modulus carbon provides a stiff, strong and light weight chassis.
3. Oversized pivot pins help create a stiff interface between the front and rear triangles of the frame. Custom Enduro Max sealed bearings keep things moving freely at the pivots.
4. The ISCG 05' tab is built into your SB6c. The built in system is lighter than a conventional tab and allows for a full myriad of chain-guide options.
5. Using our inset head tube on the SB6c allows for a larger head tube with more area, increased stiffness, and lower overall ride height without compromising any performance.
6. The SB6c uses a 2.5 inch stroke, 8.5 inch eye to eye Float-X shock, by Fox Racing Shox.
7. Custom chain-slap guards on the seat stay and chain stay keep things quiet while riding and protect the frame.
8. The SB6c features internal cable routing for clean protected cables and a very clean looking bike.
9. The SB6c has a removable front derailleur mound specifically designed around the new Shimano side swing D-Type front derailleur.
10. Dedicated Boost 12 x 148 dropouts for strength, stiffness and ease of wheel installation.

GEOMETRY

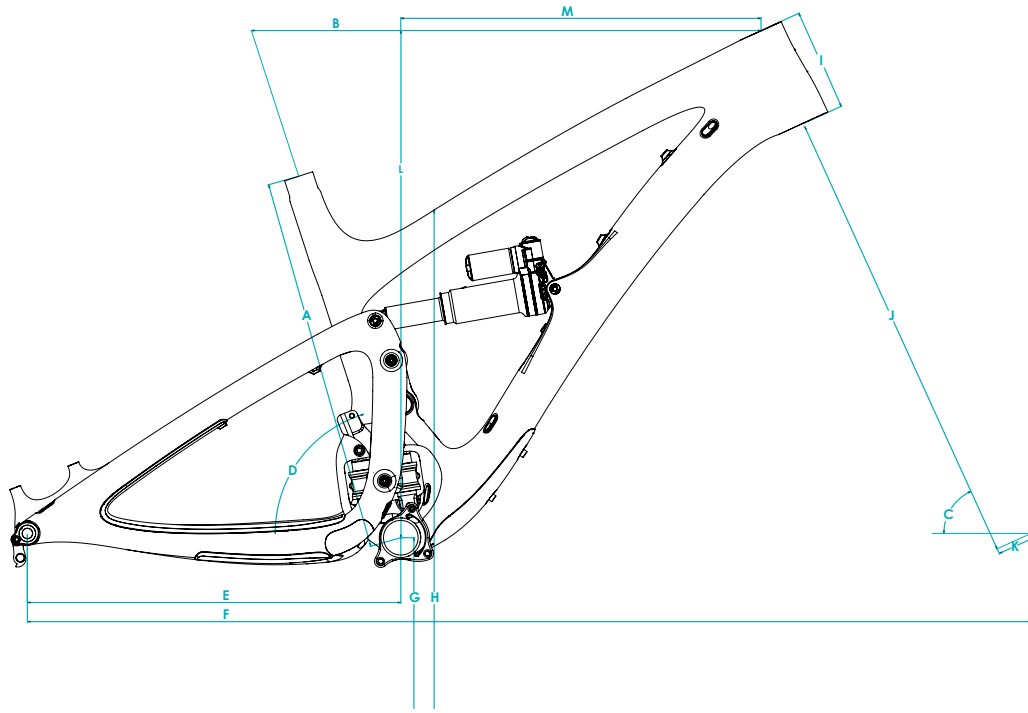

FOX 36 / 160MM FORK

	XS	SM	MD	LG	XL
A	15.0	16.5	17.5	19	20.5
B	21.8	22.8	23.8	24.8	25.8
C	65.5	65.5	65.5	65.5	65.5
D	73.5	73.5	73.5	73.5	73.5
E	17.4	17.4	17.4	17.4	17.4
F	44.6	45.7	46.8	47.8	48.9
G	13.6	13.6	13.6	13.6	13.6
H	28.7	28.8	28.9	28.9	28.9
I	3.7	4.3	4.8	5.6	6.3
J	21.6	21.6	21.6	21.6	21.6
K	1.73	1.73	1.73	1.73	1.73
L	22.6	23.2	23.6	24.4	25.0
M	15.1	15.9	16.8	17.6	18.3

All measurements are in inches

FIT

X-SMALL 4'11" (145CM) - 5'3" (160CM)

SMALL 5'3" (160 CM) - 5'7" (170 CM)

MEDIUM 5'7" (170 CM) - 5'11" (180 CM)

LARGE 5'11" (180 CM) - 6'3" (191 CM)

X-LARGE 6'3" (191 CM) - 6'6" (198 CM)

KEEP YOUR YETI FRESH AND CLEAN

OVERVIEW

Following these guidelines will help maintain the performance of your bicycle and prevent more serious problems from arising. It is important to remember that service intervals can vary depending on climate, trail conditions and riding frequency. If you are unsure about working on your own bicycle, contact your authorized Yeti Dealer or visit the repair help section at www.parktool.com for more information on general bicycle maintenance.

SCHEDULE

	WEEKLY	MONTHLY	3 MONTHS	ANNUALLY
CLEAN AND LUBE CHAIN	■			
CHECK TIRE PRESSURE	■			
CLEAN BIKE OF MUD AND DEBRIS	■			
CHECK BRAKE FUNCTION	■			
CHECK SHOCK PRESSURE, IF APPLICABLE	■			
CHECK FOR LOOSE BOLTS AND TIGHTEN, IF NECESSARY	■			
CHECK HEADSET AND TIGHTEN / LOOSEN, IF NECESSARY		■		
THOROUGHLY CLEAN PIVOT POINTS WITH A RAG (DO NOT LUBRICATE)		■		
LUBE INFINITY LINK EVERY 40 HRS. (YETI HEAVY MOLYBDENUM GREASE)		■		
REPLACE BRAKE PADS, IF NECESSARY			■	
CHECK TIRES FOR WEAR			■	
CHECK SPOKE TENSION AND RETENTION, IF NECESSARY			■	
CHECK CHAIN FOR WEAR AND REPLACE IF NECESSARY			■	
COMPLETE TUNE-UP PERFORMED BY AN AUTHORIZED YETI DEALER				■

TORQUE

Yeti strongly recommends using a torque wrench when assembling your frame. Torque specifications for individual parts on the SB6c are listed below, as well as in the step by step assembly instructions later in the manual. For general bicycle maintenance please consult the torque specifications of the manufacture's component you are adjusting.

KEY TORQUE SPECS

PART NUMBER	DESCRIPTION	TORQUE (NM)
300030151	BOLT TI MALE M6X1X12MM	7
300030057	INFINITY LINK BOLTS	12
300040454	COLLET BOLT M8	8
300040480	UPPER LINK COLLET AXLE	3
300040478	LOWER LINK AXLE	13
300040479	MAIN PIVOT COLLET AXLE	3.5

SHOCK SETUP

YETI TIPS

Inspect your shock for any visible damage. If oil is leaking or you notice any damage to the surfaces or seals, please contact the Fox Racing Shox service center for repair at 800.FOX.SHOX or your local bike shop.

Shock set-up can fluctuate greatly based on the rider. The set-up guide is intended as a base line to get the rider started. Experiment with your settings to find the set-up that works best for you.



TOOLS NEEDED

- Shock Pump
- Metric Tape Measure



QUICK START GUIDE

ADJUSTMENT	SETTING
AIR SPRING SETTING (PSI)	RIDER WEIGHT LESS 10 PSI
MEASURED SAG (MM)	17-18MM
REBOUND	*5 CLICKS
TRAIL ADJUST	OPEN (DESCEND)

**All clicks are counted clockwise, rotating from the all the way out or counter-clockwise dial position. Number of clicks of rebound will vary based on air pressure.*



01. AIR PRESSURE

The main air spring controls the sag of the shock. For the SB6c to ride properly it is important to setup the shock with the correct amount of sag. The SB6c works best with 18-19MM of measured sag. To increase the sag reduce the main spring air pressure. To reduce the sag increase the main spring air pressure. Cycle the shock 5-10 times to equalize the EVOL chamber before measuring sag.



03. REBOUND AND COMPRESSION

The rebound has 14 clicks of adjustment. The rebound knob is the red adjustment dial located at the front of the air can. When the shock is mounted on the bike a small allen wrench is the best way to rotate it. Slower rebound- turn the knob clockwise, Faster rebound- turn the knob counter-clockwise.

Compression is adjusted 2 ways. Low speed compression can be tuned for the "open" position with the black adjuster, giving the shock 3 positions. The Blue lever is a 3 position lever: Open, Medium and Firm. For our bikes, unless you are on pavement, we recommend using the "open" setting. The Switch Infinity design will do the rest!



02. SAG

Once you have set your baseline air pressure you need to measure the sag. To measure the sag slide the travel indicator (O-Ring) up against the shock body. With a friend supporting the bike and with the shock in "open," sit on the saddle (do not bounce) and allow your body weight to compress the shock. Once you have compressed the shock, get off the bike and measure the distance between the shock body and the new position of the travel indicator (O-Ring). This is your sag.



DERAILLEUR HANGER INSTALL

YETI TIPS

NOTE: The hanger cap is REVERSE THREADED. Be careful not to strip out the Hanger tool faces. The cap is marked with a tighten direction arrow.

Inspect the frame around the hanger seat for any suspicious damage any time you replace a hanger, but especially if you are replacing it due to damage.

TOOLS NEEDED

- 6mm Allen key
- Grease



01. HANGER SEAT

Lightly grease the outside surface of the hanger where it interfaces with the frame. The hanger will fit into its space on the inside of the swingarm and presses easily into the frame.



02. HANGER CAP SEAT

Lightly grease the thread on the hanger cap. The hanger cap REVERSE threads into the hanger from the outside of the swing arm. Hand thread the cap into the hanger.



03. TIGHTENING

Using a 6mm allen key, tighten the hanger cap into the hanger. REMEMBER, it is REVERSE THREADED. Follow the "Tighten" arrow on the cap.

**Torque to 80 in/lbs (9Nm)*



02. COMPLETED

The installed hanger and cap should look like this, sitting flush against the frame on both the inside and outside of the swing arm. If the hanger or cap are not sitting flush against the frame, remove them and inspect the frame surfaces for debris as well as the threads for damage.

CABLE HOUSING SETUP

The SB6c uses internally routed full length cable housing. By using full cable housing, we have eliminated break points in the line of your shifter housing. This allows riders to experience better overall shifting performance by reducing the entrance of unwanted elements such as sweat and sediment. By routing that housing internally we add to the protection from the elements and clean up the lines of the bike. No more zip ties to snag your shorts on and no more loose housing rattling around on your paint.

Do not remove any of the housing guide tubes that are installed in your frame and swingarm. They will be used to pull your housing through the frame. If you are replacing housing, use the old housing to pull your new housing through the frame.

If you don't have the tubes or old housing as a guide you can fish for it, but it will be easier to get an internal routing tool.

Caution: The failure to properly route shifter housing can cause malfunction of the shift mechanism and unexpected shifting of gears.



REAR BRAKE AND DERAILLEUR ROUTING.

Your rear brake and shifter housing will run parallel around the left side of the head tube. From there you will run those two into the housing ports on the non drive side of the head tube. The Rear shift housing and brake housing exit the front triangle just above the Infinity Link. The brake exiting on the non drive side, the shift exiting on the drive side, both continuing into the corresponding port on the swing arm.

*Use rubbing alcohol to lubricate the housing. It will pass through the rubber grommets much easier.

*It may be easier in some cases to run the housing from the back of the bike up.



REAR BRAKE CONTINUED

The rear brake housing will exit the swing arm via the port on the chainstay and go from there directly to the brake caliper. If possible, adjust the housing/caliper angle to give the housing the cleanest, shortest route to the port.



REAR DERAILLEUR CONTINUED

The rear shift housing exits the swing arm on the top, just above the derailleur. Make sure you leave enough slack in the housing to allow for a smooth curve from the housing port to the derailleur.



DROPPER POST

The dropper post housing will exit the frame at the upper port on the drive side of the head tube. It is best to run the housing from the seatpost up using either the guide provided with a new frame or the previous housing. Without a guide, it can be difficult to fish the housing into the downtube, but it is possible.

FRAME ASSEMBLY

YETI TIPS

Make sure your tools are in good condition. A worn allen key can round the hex on a bolt not allowing for proper torque.

Torque settings are listed throughout the instructions. It is also important to prep all bolt threads. The instructions denote whether to use a Loctite compound or grease.

Warning: Service on Yeti bicycles requires special knowledge and tools. Yeti Cycles recommends that all service and repairs be performed by an authorized Yeti Dealer

TOOLS NEEDED

- Dead blow hammer
- 2.5mm allen key
- Two - 5mm allen keys
- Two - 6mm allen keys
- 10mm allen key
- Guide pin tool
- Lock ring pliers
- Grease
- Blue (248) Loctite
- Pink (222) Loctite
- Torque wrench



01.

All the parts you'll need to get your SB6c put together.



02.

Slip washers onto and apply blue (248) Loctite to the 4 bolts that secure the Switch Infinity Link to the frame. Insert them into their place and hang the black Infinity link fitting washers from them. Place them with the flat side toward the opening.



03.

Insert the Infinity Link from the non-drive side. The Infinity logo should be up and the Fox logos facing the non-drive side. Rock the link into place capturing the black fitting washers. Make sure that they have not slipped or rotated. The flat end of the fitting washers must be facing the opening in the frame.



04.

While holding the link in place lightly tighten the bolts. You want them to be snug so that the link does not move and so that the fitting washers are fully captured, but don't try to torque them by hand! Finish the job with a torque wrench.

Torque to 12 Nm





05.

Insert the link and align the lower pivot. Place the steel washer over the pivot pin, apply a small amount of grease, and using a Fox Guide Pin to align the bearing spacer insert the pivot pin. Use a soft mallet to tap it through if needed.



06.

Place the steel washer on the lower link bolt and apply pink Loctite (222).



09.

Slide the main pivot pin through the swingarm and Infinity Link using a Fox Guide Pin to align the bearing spacer. Use a soft mallet to help if needed. Lightly thread the pivot pin into the swingarm using a 10mm allen wrench. Do not torque yet.



10.

Prepare and install the upper link pivot pin the same way you install the main pivot pin. Use the Fox Guide pin to align the bearing spacer as you slide it through the link. Again, do not torque yet!



07.

Using two 5mm allen wrenches tighten the lower link pivot pin. Use a properly calibrated torque wrench to finish the job.

Torque to 13 Nm



08.

Slide the swingarm into place over the Switch Infinity Link and align the main pivot. Apply a small amount of grease to the un-threaded part of the main pivot pin. Apply pink Loctite (222) to the threads.



11.

Using Fox Guide Pins, install the rear shock as shown. Insert the guide pins from the drive side.



12.

Lightly grease the shock mounting hardware, install the appropriate washer and place the female sleeve over the Fox Guide Pin.



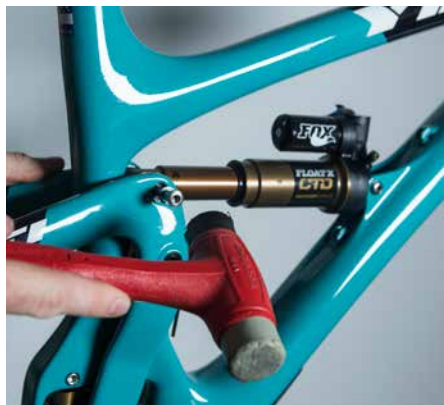

13.

Using a soft mallet push the female shock mounting hardware through the frame and shock on the Fox Guide Pins.



14.

Prep and install the male shock mounting hardware on both ends of the shock. Apply Blue Loctite (248) to the threads and install the washer. Thread the bolt in snug, but do not torque.



17.

Prepare both your collet bolts with grease. You want to have grease on the threads and on the collet wedge.

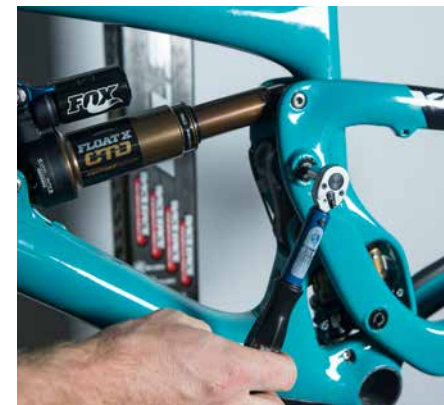

18.

Using a 5mm allen wrench, thread both collet bolts into the pivot axles. Finish tightening using a properly calibrated torque wrench.

Torque to 8 Nm



15.

Time to get the torque wrench out. Using a 5mm allen on one side and your properly calibrated torque wrench on the other torque the shock mounting hardware on both ends of the shock.

Torque to 7 Nm



16.

Using a 10mm allen wrench finish tightening the main pivot axle and the upper link axle. Torque the pivot axles using a properly calibrated torque wrench.

Torque to 3.5 Nm

FRAME ASSEMBLY IS COMPLETE. NOW GET YOUR PARTS ON THERE AND GO FOR A RIDE!

EXPLODED VIEW

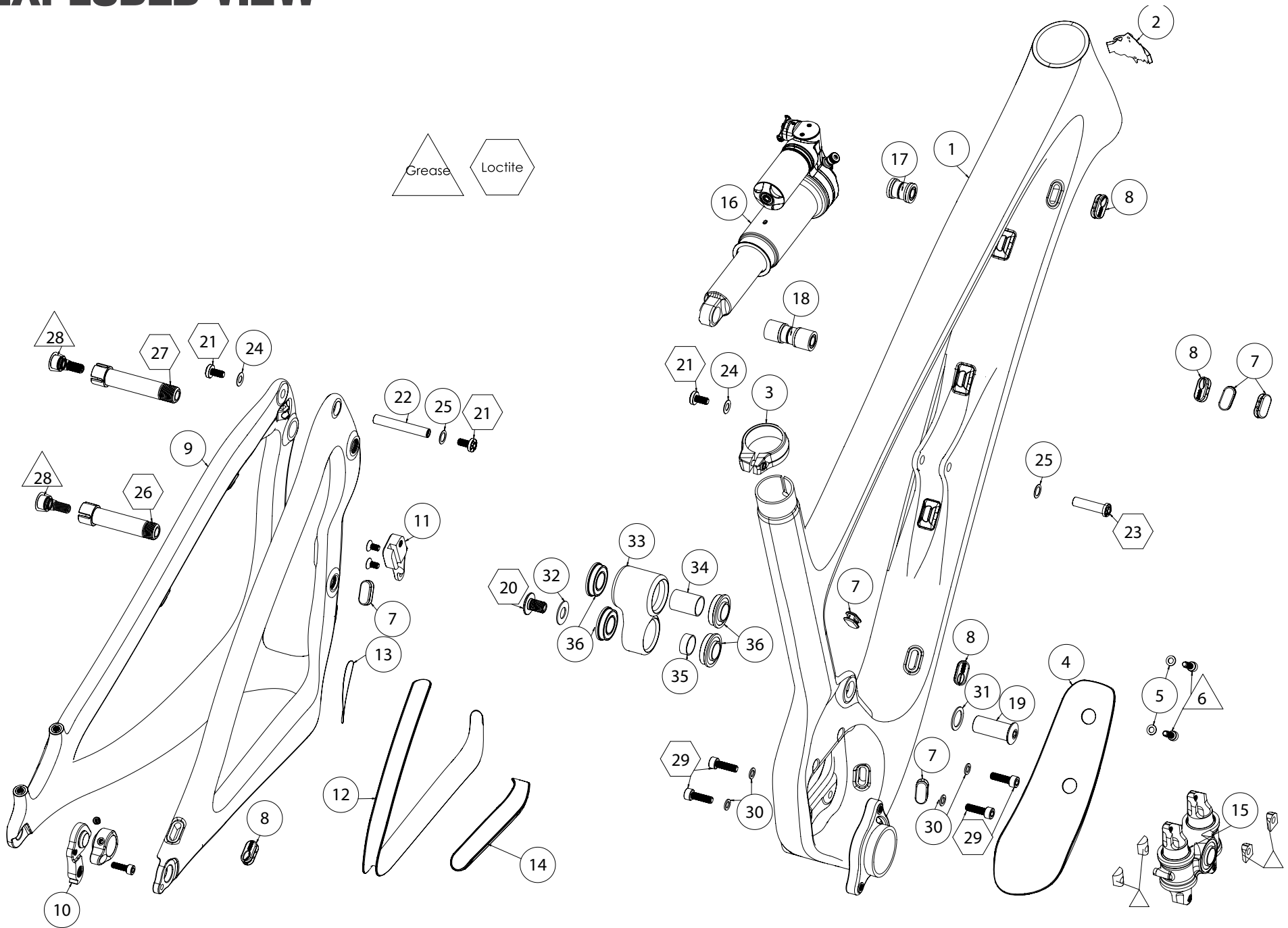
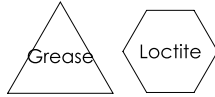

EXPLODED VIEW PARTS LIST

ITEM#	PART #	DESCRIPTION	QTY
1	N/A	SB6C FRONT TRIANGLE	1
2	300070006	ICE AXE HEAD BADGE	1
3	300060072	YETI SEAT CLAMP	1
4	400100119	SB6C DOWN TUBE PROTECTOR	1
5	300030148	WASHER 5.1 X 8.9 X 1MM	2
6	300030010	BOLT-CAP H20 (M5 X 0.8 X 16MM)	2
7	300040474	GROMMET BLANK	2
8	300040475	GROMMET 5MM	2
9	N/A	SB6C SWINGARM	1
10*	300060073	12X148 HANGER (2016 NOT PICTURED)	1
10*	300060070	12X142 HANGER STD KIT GEN2 (2015)	1
11	300040476	SB6C FD DIRECT MOUNT	1
12	400100120	SB6C CS/SS PROTECTOR	1
13	400100121	SB6C CHAINDUCK GUARD	1
14	400100122	SB6C CS LOWER PROTECTOR	1
15	200020201	FOX LINEAR BEARING ASSEMBLY	1
16	N/A	FOX FLOAT-X 8.5 X 2.5	1
17	214-09-006	FOX MOUNT KIT 21.84MM (22MM)	1
18	214-09-035	FOX MOUNT KIT 44.856MM (45MM)	1
19	300040478	AXLE 15MM X 36.0, M10 X 1.5 THREAD	1
20	300030280	CAP AXLE 15MM, M10 X 1.5 THREAD	1
21	300030151	BOLT TI MALE M6 X 12.0MM	3
22	300030288	BOLT TI STUD 8.0 X 54.0MM	1
23	300030262	BOLT TI FEMALE 8.0 X 31.0MM GEN2	1
24	300030062	WASHER 6.5 X 12.5 X 0.5 MM	2
25	300030069	WASHER 8.8 X 12.5 X 0.5 MM	2
26	300040479	COLLET AXLE 15 X 52.0S X 9.75T M15X1.5	1

ITEM#	PART #	DESCRIPTION	QTY
27	300040480	COLLET AXLE 15 X 55.5S X 14.0T M15X1.5	1
28	300040454	COLLET WEDGE ASSEMBLY GEN2	2
29	300030057	BOLT CAP M6 X 1 X 20MM	4
30	300030214	WASHER 10 X 6.2 X 1MM	4
31	300030276	WASHER 15.2 X 21.5 X 1MM	1
32	300030277	WASHER 10.4 X 21.5 X 1MM	1
33	300040477	SB6C LINK	1
34	300030248	SPACER 15MM X 25.75MM	1
35	300030278	SPACER 15MM X 6.75MM	1
36	300020045	BEARING F6902-2RS-MAX 28X15X7_2.5 OUT	4

REBUILD KITS

PART #	DESCRIPTION	QTY
200020232	SB6C MASTER REBUILD KIT	
300020045	BEARING F6902 2RS 28X15X7 OUT	6
300030057	BOLT CAP M6X1X20	4
300030062	WASHER SS 6.5MM ID 12.5 OD .5M	2
300030069	WASHER SS 8.8MM ID 12.5MM OD .	2
300030151	BOLT-TI-MALE M6X12MM	3
300030154	STUD-TI-FEMALE 8X54.5MM	1
300030214	WASHER 10 X 6.2 X 1	4
300030248	SPACER 15X25.75MM	1
300030249	BOLT-TI-FEMALE 8.0OD M6X31.5M	1
300030276	WASHER 15.2X21.5X1	1
300030277	WASHER 10.4X21.5X1	1
300030278	SPACER 15X6.75MM	1
300030279	FLAT HEAD M5X.8X10	2
300030280	CAP AXLE M10X1.5X15 GEN2	1
300040454	COLLET-WEDGE ASSEMBLY GEN2	2
300040474	PORT GROMMET BLANK	5
300040475	PORT GROMMET 5MM	4
300040476	FD DIRECT MOUNT REMOVABLE	1
300040478	AXLE 15MM X 36.0 M10X1.5 GEN2	1
300040479	AXLE COLLET 15X52.0SX9.75T	1
300040480	AXLE COLLET 15X55.5SX14.0T	1
200020232	SB6C BEARING KIT	
300020045	BEARING F6902 2RS 28X15X7 OUT	6

PART#	DESCRIPTION	QTY
200020233	SB6C HARDWARE KIT	
300030057	BOLT CAP M6X1X20	4
300030062	WASHER SS 6.5MM ID 12.5 OD .5M	2
300030069	WASHER SS 8.8MM ID 12.5MM OD .	2
300030151	BOLT-TI-MALE M6X12MM	3
300030154	STUD-TI-FEMALE 8X54.5MM	1
300030214	WASHER 10 X 6.2 X 1	4
300030249	BOLT-TI-FEMALE 8.0OD M6X31.5M	1
300030276	WASHER 15.2X21.5X1	1
300030277	WASHER 10.4X21.5X1	1
300030278	SPACER 15X6.75MM	1
300030279	FLAT HEAD M5X.8X10	2
300030280	CAP AXLE M10X1.5X15 GEN2	1
300040454	COLLET-WEDGE ASSEMBLY GEN2	2
300040474	PORT GROMMET BLANK	5
300040475	PORT GROMMET 5MM	4
300040476	FD DIRECT MOUNT REMOVABLE	1
300040478	AXLE 15MM X 36.0 M10X1.5 GEN2	1
300040479	AXLE COLLET 15X52.0SX9.75T	1
300040480	AXLE COLLET 15X55.5SX14.0T	1
200020237	SB6-C FRONT DERAILLEUR MOUNT KIT	
300030279	FLAT HEAD M5X.8X10	2
300040476	FD DIRECT MOUNT REMOVABLE	1
200020234	FOX LINEAR BEARING 74.0MM SB6	
200020201	FOX LINEAR BEARING 74.0MM ASSE	1
300030057	BOLT CAP M6X1X20	4
300030214	WASHER 10 X 6.2 X 1	4

REBUILD KITS CONTINUED

PART #	DESCRIPTION	QTY
400100126	SB6C PROTECTOR KIT	
400100119	PROTECTOR SB6-C DT	1
400100120	PROTECTOR SB6-C CS/SS	1
400100121	PROTECTOR SB6-C CHAIN SUCK	1
400100122	PROTECTOR SB6-C CS LOWER	1
200020236	SB6-C CABLE GUIDE KIT 2014-	
300040474	PORT GROMMET BLANK	5
300040475	PORT GROMMET 5MM	4

WARRANTY

YETI LIMITED (5) FIVE YEAR FRAME WARRANTY

(applies to SB4.5c / SB5c / Beti SB5c / SB6c / ASRc / Beti ASRc)

Yeti Cycles will repair or replace, at its option, any frame it determines to be defective due to defective materials and/or workmanship. The (5) one year limited warranty is conditioned upon the bicycle being ridden under normal conditions and having been properly maintained. This warranty does not apply to the components attached to the frameset such as suspension components, wheels, drive train, brakes, seatpost, handlebar and stem. This warranty applies only to the original owner and is non-transferable. This warranty is void if the bicycle was not properly assembled by an authorized Yeti dealer.

YETI LIMITED (2) TWO YEAR FRAME WARRANTY

(applies to ARC-C / ASR 5-C / ASR 5-A / SB66-A / SB66-C / SB95 / SB95 -C / SB75 / 575 / ARC / Big Top 29'r)

Yeti Cycles will repair or replace, at its option, any of the above listed frames it determines to be defective due to defective materials and/or workmanship. The (2) five year limited warranty is conditioned upon the bicycle being ridden under normal conditions and having been properly maintained. This warranty does not apply to the components attached to the frameset such as suspension components, wheels, drive train, brakes, seat post, handlebar and stem. This warranty applies only to the original owner and is non-transferable. This warranty is void if the bicycle was not properly assembled by an authorized Yeti dealer.

ADDITIONAL CONDITIONS

These limited warranties do not apply to normal wear and tear, nor to claimed defects, malfunctions or failures that result from abuse, neglect, improper assembly, improper maintenance, alteration, collision, crash or misuse. The original owner shall pay all labor charges connected with the repair or removal of all components. Under no circumstance does this limited warranty include the cost of travel or shipment to and from an authorized Yeti dealer. In order to exercise your rights under these limited warranties, the bicycle or frameset must be presented to an authorized Yeti dealer, together with proof of purchase.

**The above warranties have been in effect since January 2012. For warranty information on Yeti frames sold prior to that date please consult your local authorized dealer.*

NO FAULT REPLACEMENT POLICY

Yeti Cycles will make replacement parts available at a minimum charge to the original owner in the event of a crash or any other non-warranty situation. Yeti Cycles does this at its sole discretion and reserves the right to refuse this offer.

PRODUCT LIFE CYCLE

Every YETI frameset has a useful product life cycle. The length of that useful product life cycle will vary depending on the construction and the materials of the frameset, maintenance and care the frameset receives, and the amount and type of use the frameset is subjected to over its life. YETI recommends that an authorized YETI dealer should inspect the frame for stress annually. Frame stress could cause potential failure and the signs are usually apparent in the form of cracks, fracture lines, deformation, dents, and any other visual indicators of abnormality. These safety checks for frame stress are important to prevent accidents, injury to the cyclist, and product failure of a YETI frameset.

DISCLAIMER

YETI Cycles is not responsible for any damages to you or others arising from riding, transporting or other use of your bicycle. In the event that your frame breaks or malfunctions, YETI Cycles shall have no liability or obligation beyond the repair or replacement of your frame pursuant to the terms outlined in the warranty.

**If you have a warranty concern, please contact your authorized Yeti dealer.*

YETI CYCLES

621 Corporate Circle, Unit B
Golden, CO 80401
(p) 303-278-6909
(f) 303-278-6906
www.yeticycles.com

BUSINESS HOURS

Monday-Friday
8AM-11:30AM, 1:00PM-5:30PM
(Mountain Time)