



OWNER'S MANUAL 2012 YETI 303 WC

YETI CYCLES
600 Corporate Circle, Unit D
Golden, CO 80401
888.576.9384

www.yeticycles.com



TABLE OF CONTENTS

BRAND OVERVIEW	06
FRAME FEATURES	08
GEOMETRY	10
MAINTENANCE SCHEDULE	12
 <i>SETUP</i>	
RAIL SYSTEM	14
FORK SETUP	16
SHOCK SETUP	18
QUICK START GUIDE	21
CABLE/LINE SETUP	22
 <i>TECHNICAL</i>	
ASSEMBLY OVERVIEW	24
AXLE OPERATIONS	30
EXPLODED VIEWS	32
REBUILD KITS	34
 <i>LEGAL</i>	
WARRANTY	36
CONTACT INFORMATION	37

CONGRATULATIONS ON YOUR PURCHASE OF A NEW YETI.

We are confident your new bicycle will exceed your expectations for value, performance, and ride quality. Each frameset and component has been custom specified and designed to enhance your riding experience. Whether you are a beginner cyclist, or a seasoned pro, your Yeti bicycle will provide endless hours of two-wheeled fun.

This model specific manual is designed to be used in conjunction with the general Yeti Owner's Manual and the manuals supplied by the suspension manufactures. If you did not receive the Yeti owner's manual or the manual provided by the suspension manufacturer download the materials off the Internet, or contact your local dealer.

Bicycling can be a hazardous activity even under the best of circumstances. Proper maintenance of your bicycle is your responsibility and when done properly helps reduce the risk of injury and damage to your bicycle.

Warning: Make sure you review and understand the warnings, instructions, and content of this manual and accompanying manuals for your bicycle.

Warning: Technological advances have made bicycles and bicycle components more complex and the pace of innovation is increasing. It is impossible for this manual or the accompanying manuals to provide all the information required to properly repair and/or maintain your bicycle. In order to help minimize the chances of an injury, it is critical for you to have work performed by an authorized Yeti retailer.

This manual outlines basic setup and maintenance recommendations of your new Yeti. Because it is impossible to anticipate every situation or condition that may occur during the assembly, setup, and maintenance of your bicycle, Yeti recommends that all service and repairs be performed by your local authorized Yeti Dealer.

This manual contains many "Warnings" and "Cautions" concerning the consequences of failure to maintain or inspect your bicycle. The word "Warning" indicates a potentially hazardous situation in which, if not avoided, could result in serious injury or death. The word "Caution" indicates a potentially hazardous situation in which, if not avoided may result in minor injuries or damage to your bicycle or a component of your bicycle. Be sure to read and understand all of the Warnings and Cautions listed in the manual.

THE 303 WC IS A PURE RACE MACHINE, BORN AND BRED ON THE WORLD CUP CIRCUIT WITH INPUT FROM OUR FACTORY TEAM.

1. CUSTOM HYDRO-FORMED ALUMINUM MAIN FRAME & SWINGARM
2. INSET 1.5 HEAD TUBE – ANGLESET COMPATIBLE
3. INTEGRATED FORK BUMPERS
4. PATENTED 303 LINEAR RAIL TECHNOLOGY
5. REMOVABLE ISCG MOUNTS
6. CUSTOM DUAL-DENSITY CHAIN SLAP GUARDS
7. REAR SHOCK BY FOX RACING SHOX

1. The fully custom hydro-formed main frame and swingarm have been maximized for stiffness and weight savings.
2. Using our new inset headtube on the 303 WC allows for a larger headtube with more welding area and increased stiffness. It is also Angleset compatible, allowing for tweaks to the geometry of the frame.
3. Integrated and replaceable fork bumpers protect your frame and fork without fail. No more worrying about keeping the rubber bumpers in place on the fork stanchions.
4. Our patented linear rail technology smooths out even the most technical races courses and allows the bike to pedal efficiently.
5. The splined BB shell can accept a removable ISCG 03' or 05' tab. The splined system is lighter than a conventional welded tab and allows for a myriad of chain-guide options.
6. Custom chain-slap guards on the seatstay and chainstay keep things quiet while riding and protect the frame.
7. The 303 WC uses a 3.0 inch stroke, 9.5 inch eye to eye shock, by Fox Racing Shox that is easily accessible for tuning.

GEOMETRY

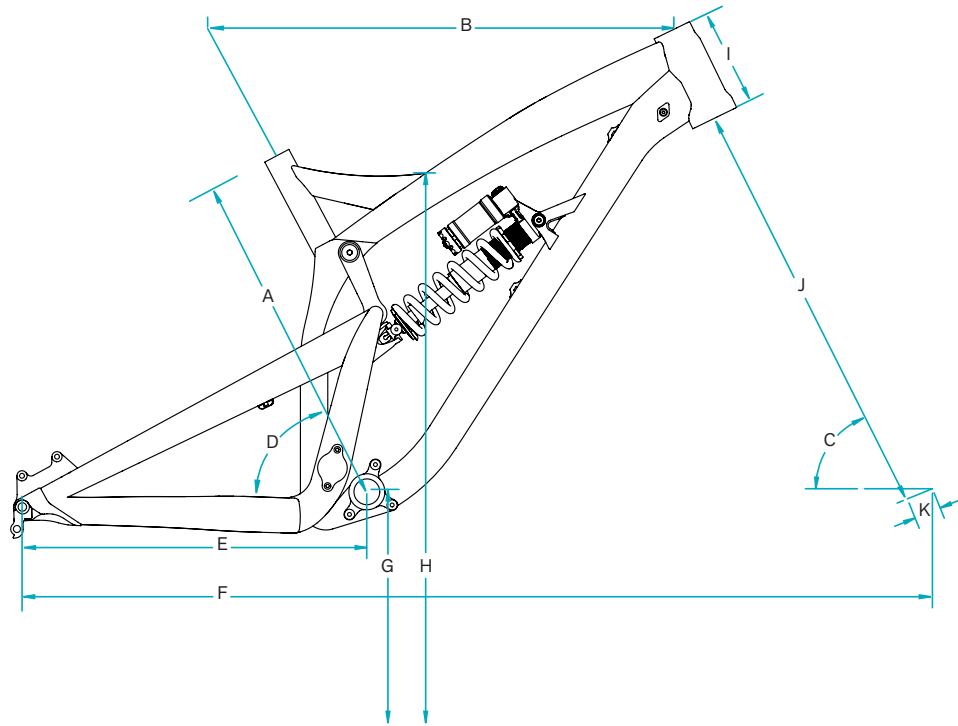

FOX 40 / 203 MM FORK

	SM	MD	LG	XL
A	17.5	17.5	17.5	17.5
B	22.5	23.2	23.8	24.6
C	63.5	63.5	63.5	63.5
D	62.0	62.0	62.0	62.0
E	17.4	17.4	17.4	17.4
F	45.6	46.4	47.0	47.8
G	13.9	13.9	13.9	13.9
H	30.0	30.0	30.0	30.0
I	5.0	5.0	5.0	5.0
J	22.5	22.5	22.5	22.5
K	1.8	1.8	1.8	1.8

**All measurements are in inches*

FIT

SMALL	5'3" (160 CM) - 5'6" (168 CM)
MEDIUM	5'6" (168 CM) - 5'9" (175 CM)
LARGE	5'9" (175 CM) - 6'1" (185 CM)
X-LARGE	6'1" (185 CM) - 6'4" (193 CM)

KEEP YOUR NEW YETI FRESH AND CLEAN

OVERVIEW

Following these guidelines will help maintain the performance of your bicycle and prevent more serious problems from arising. It is important to remember that service intervals can vary depending on climate, trail conditions and riding frequency. If you are unsure about working on your own bicycle, contact your authorized Yeti Dealer or visit the repair help section at www.parktool.com for more information on general bicycle maintenance.

SCHEDULE

	WEEKLY	MONTHLY	3 MONTHS	ANNUALLY
CLEAN AND LUBE CHAIN	■			
CHECK TIRE PRESSURE	■			
CLEAN BIKE OF MUD AND DEBRIS	■			
CHECK BRAKE FUNCTION	■			
CHECK SHOCK PRESSURE, IF APPLICABLE	■			
CHECK FOR LOOSE BOLTS AND TIGHTEN, IF NECESSARY	■			
CHECK HEADSET AND TIGHTEN / LOOSEN, IF NECESSARY		■		
THOROUGHLY CLEAN PIVOT POINTS WITH A RAG (DO NOT LUBRICATE)		■		
REPLACE BRAKE PADS, IF NECESSARY			■	
CHECK TIRES FOR WEAR			■	
CHECK SPOKE TENSION AND RETENTION, IF NECESSARY			■	
CHECK CHAIN FOR WEAR AND REPLACE IF NECESSARY			■	
COMPLETE TUNE-UP PERFORMED BY AN AUTHORIZED YETI DEALER				■

TORQUE

Yeti strongly recommends using a torque wrench when assembling your frame. Torque specifications for individual parts on the 303 WC are listed below, as well as in the step by step assembly instructions later in the manual. For general bicycle maintenance please consult the torque specifications of the manufacture's component you are adjusting.

KEY TORQUE SPECS

PART NUMBER	DESCRIPTION	TORQUE (IN/LB)
300030119	BOLT SHC M5X0.8X10MM	50-55
300030017	BOLT SHC M6X1X25MM	125-130
300030110	BOLT TI MALE M6X1X12MM	90-95
300030122	BOLT SHC M6X1X18MM	40-45
300030194	BOLT SHC M4X10MM	10-15
HNAWCDAABA0000PVT0001	303 WC DOGBONE PIN CAP	125-130
HNA0000000M408BLT0000	BOLT SHC M4X8MM	30-35
HNAWCDAABAM217PVT0000	PIN MALE 303 WC M12X1.75	175-180
HNAWCDAABAAA00SHX0000	BOLT 303 WC SHOCK EXTENDER	95-100

RAIL SYSTEM

OVERVIEW

Both the rail and block are made from proprietary carbon steel. The rail is then case hardened to between 58 and 64Rc. An Armalloy surface treatment is applied to the rail and the block for corrosion protection and wear resistance. The ball bearings are made from martensitic stainless steel - which is equal to a 440 stainless. End scrapers, end seals, inner seals, and side seals prevent contaminants from entering the system.

There is also a custom grease port on the end of the block. Grease should be applied with the supplied applicator as needed based on riding conditions, weather and ride time. A good rule of thumb is to grease the rail after each bike wash. After application the suspension needs to be cycled 6-10 times to spread the grease evenly throughout the bearing raceways and ports in the block.



01. RAIL LUBRICATION

Fill the supplied syringe with a high quality lightweight grease. Remove the plunger on the syringe and pack it with the grease. Once the syringe is filled, press the end of the rubber line onto the grease port as shown. Compress the syringe to force grease into the rail system.



02. RAIL LUBRICATION

After you have completed the initial lubrication, weight and unweight the bike to compress the shock and actuate the rail system. If you see residual grease left on the rail after cycling the suspension you have sufficiently lubricated the system. After lubrication it is extremely important to clean off any excess grease on the rail before riding. If the rail is not completely clean the grease will attract more contaminants to the rail system.

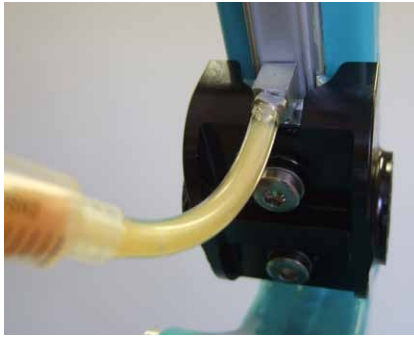

FORK SETUP

OVERVIEW

Before riding the 303-WC it is extremely important that the clearance between the upper fork crown and the top tube on the frame is checked. If improperly set up the fork crown can contact the top tube causing irreparable damage to the frame. Please consult the following instructions for all fork installations on the 303-WC.

Caution: The failure to properly set up the fork on the 303 WC can cause serious and irreparable damage to the frame. If you have any concerns about proper fork setup please consult your local authorized dealer.



01.

Remove the drive side rubber bumper by unthreading the M4 button head bolt with a 3MM allen key.



02.

Slowly rotate the fork clockwise. If the fork stanchion touches the outer face of the bump stop housing before the upper crown touches the top tube, the fork is properly set up.



03.

If the upper crown touches the top tube before the stanchion touches the bump stop housing until there is at least 5MM of clearance between the top tube and upper crown. Using a Rock Shock Boxxer "tall" upper crown will require a minimum of 10MM of spacers for adequate clearance.



04.

Install the drive side rubber bumper with a 3MM allen key.

Torque to 5-10 in/lb.

SHOCK SETUP

YETI TIPS

Inspect your shock for any visible damage. If oil is leaking or you notice any damage to the surfaces or seals, please contact the Fox Racing Shox service center for repair at 800.FOX.SHOX.

Shock set-up can fluctuate greatly based on the rider. The set-up guide is intended as a base line to get the rider started. Experiment with your settings to find the set-up that works best for you.



TOOLS NEEDED

- Shock Pump
- Tape Measure
- 2.5mm allen key
- 3mm allen key



01. BOTTOM-OUT RESISTANCE

The bottom-out adjuster has four turns of adjustment. This adjustment controls the bottoming resistance of the shock, meaning it controls the compression on the final part of the shocks stroke. The adjuster can be turned by inserting a 3MM allen key into one of the holes around the perimeter of the dial. For more resistance turn the dial clockwise. For less resistance turn the dial counter-clockwise.



02. BOOST VALVE

The DHX RC4 has an air pressure range of 125-200 psi, and it must be pressurized. The boost valve allows for seamless transition from small bumps to big drop bottom-outs. For more bottom out control add air pressure in 10 to 15 pound increments to a maximum of 200 psi. For less bottom out control decrease the air pressure to a minimum of 125 psi.



03. SAG

With a friend supporting the bike, stand on the pedals and allow your body weight to compress the shock. Remain on the bike have your friend measure the eye to eye length of the shock. Subtract this measurement from the static eye to eye of the shock (9.5") to get your sag measurement in inches. Divide this number by the shocks stroke (3") to get your sag percentage. The 303 WC rides best at 25-30% sag.



04. LOW SPEED COMPRESSION

The LSC adjuster has an 18 click range of adjustment that is controlled with the blue dial located on the piggyback. The LSC adjuster primarily affects the compression damping during slow speed suspension movements. For more low speed damping turn the dial clockwise. For less low speed damping turn the dial counter-clockwise.





05. HIGH SPEED COMPRESSION

The HSC adjuster has a twelve click range that can be adjusted by inserting a 2.5mm allen key into one of the angled holes located just below the LSC dial. The HSC adjuster mainly affects the compression damping during medium-to-fast suspension movements. For more high speed damping turn the dial clockwise. For less high speed damping turn the dial counter-clockwise.



06. REBOUND

Rebound controls the rate at which your shock returns after it has been compressed. As a general rule, adjustments that are too fast (counter-clockwise adjustment) will produce a springy ride with excessive kick-up of the rear end causing a bucking sensation. Adjustments that are too slow (clockwise adjustment) will cause packing of the rear wheel indicated by a sluggish ride feeling ride. The rebound has 15 clicks of adjustment. For slower rebound, turn the red adjuster knob clockwise. For faster rebound, turn the red adjuster knob counter-clockwise.

QUICK START GUIDE - RC4

ADJUSTMENT	SETTING
BOOST VALVE (PSI)	150 PSI
MEASURED SAG (INCHES)	0.75-0.875
REBOUND	*6 CLICKS
LOW SPEED COMPRESSION	*6 CLICKS
HIGH SPEED COMPRESSION	POSITION 0
BOTTOM OUT CONTROL	*0 TURNS

**All clicks and turns are counted clockwise, rotating from the all the way out or counter - clockwise dial position.*

SPRING WEIGHTS - 303 WC

SPRING (IN/LBS)	RIDER WEIGHT (LBS)
350	145-165
400	165-185
450	185-215

CABLE SETUP

YETI TIPS

The 303 WC has full cable housing. By using full cable housing, we have eliminated break points in the line of your shifter housing. This allows riders to experience better overall shifting performance by reducing the entrance of unwanted elements such as sweat and sediment. Use of full cable housing helps prevent corrosion from the elements, damage from chain slap, and keeps the shifting smoother for a longer period of time.

Caution: The failure to properly route shifter housing can cause malfunction of the shift mechanism and unexpected shifting of gears.



01. REAR DERAILLEUR

Fit the housing from the rear shifter along the head tube and down the cable stops on the top of the down tube. There are two cable stop groups on the top of the down tube to which housing and brake line can be attached, each with two positions to secure housing. Use the position closest to the drive side of the frame for the rear derailleur housing and secure the line with zip-ties. Next route the housing internally through the drive side seatstay. Work the housing through the two holes on the drive side seatstay and loop into the rear derailleur to finish.



02. REAR BRAKE

The rear brake line loops across the head tube and runs down the cable stops on the top of the down tube. Use zip ties to secure the line to the position closest to the non-drive side on the cable guides. Next, run the line below the shock, between the non-drive side of the swingarm and the downtube and across the single cable guide on the bottom of the non-drive seatstay. Secure the line to the guides with zip ties. Ensure the line is finished on the inside of the seatstay when attached to the caliper body. This will prevent the brake line from being compromised if the bike or rider falls.

ASSEMBLY

YETI TIPS

Make sure your tools are in good condition. A worn allen key can round the hex on a bolt not allowing for proper torque.

Torque settings are listed throughout the instructions. It is also important to prep all bolt threads. The instructions denote whether to use a blue Loctite compound or grease.

While the assembly of the 303 WC is possible with standard allen wrenches, the use of a small ratchet with allen key bits will greatly increase the ease of assembly.

Warning: Service on Yeti bicycles requires special knowledge and tools. Yeti Cycles recommends that all service and repairs be performed by an authorized Yeti Dealer

TOOLS NEEDED

- Dead blow hammer
- 3mm allen key
- 4mm allen key
- Two - 5mm allen keys
- Two - 6mm allen keys
- Guide pin tool
- Grease
- Blue loctite

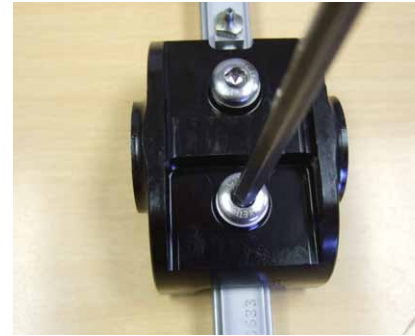

01.

Attach the car mount to the guide with two M6 Ti male bolts prepped with washers and blue loctite. Orient the car mount so the cutaway fits around the grease port on the guide.

Torque to 90-95 in/lb.



02.

Prep four M4X8mm SHC bolts with washers and blue loctite. Install the bolts through the lower two holes on each side of the car mount and into the guide with a 4mm allen key.

Torque to 30-35 in/lbs.



03.

Attach the guide assembly to the frame using four M6x1x25mm SHC bolts prepped with washers and blue loctite. The cutaway and grease port should be at the top of the rail assembly. Tighten the bolts with a 5mm allen key.

Torque to 125-130 in/lbs.



04.

Slide the dogbone over the top tube and align it with the bore in the frame. Ensure the side of the dogbone with the smaller flat surface faces the front of the frame.

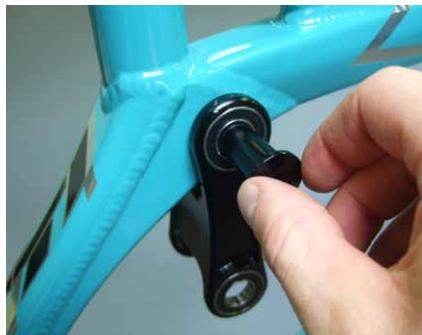

**05.**

Grease the dogbone pin and install it through the dogbone and frame from the drive side of the frame. Use a dead blow hammer to tap the pin into place.

**06.**

Apply blue loctite to the threads on the dogbone pin cap. Install and tighten the cap into the dogbone pin with two 6mm allen keys.

Torque to 125-130 in/lb.

**09.**

Install a main pivot insert through the bearing on the drive side of the swingarm. Lightly grease the outer surface and align the holes in the insert with the holes in the car mount. The lip of the insert should be flush with the outer face of the bearing. Repeat the process for the non-drive side.

**10.**

Attach the drive side main pivot insert to the car mount with two M5x0.8x10mm SHC bolts prepped with washers and blue loctite using a 4mm allen key. Repeat the process for the non-drive side.

Torque to 50-55 in/lbs.

**07.**

Slide the rear triangle over the car mount assembly and around the lower portion of the dogbone.

**08.**

Grease the shaft of a 303 WC male pin and prep the threads with blue loctite. Insert the pin through the dogbone and into the female threads on the drive side of the swingarm, tightening with a 6mm allen key. Repeat the process for the non-drive side.

Torque to 175-180 in/lb.

**11.**

Prep an M6x12mm male Ti bolt with blue loctite and install into the 68mm Ti stud. Place a 8.5x15.5x0.5mm washer over the stud.

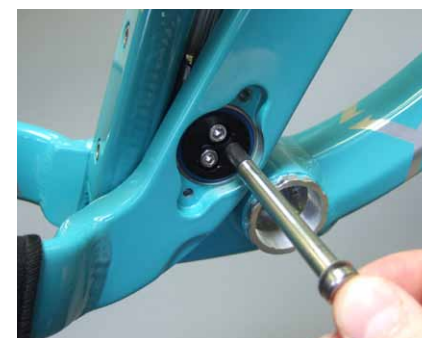
**12.**

Use the fox guide pin tool and a dead blow hammer to install the assembly created in step 11 through the main pivot inserts and car mount from the drive side of the frame. Use a Ti male bolt prepped with blue loctite on the non-drive side and tighten with two 5mm allen keys.

Torque to 90-95 in/lb.





13.

Tighten a bearing cap into the recess on the drive side of the swingarm with two M5x0.8x10mm SHC bolts prepped with washers and blue loctite. Repeat the process for the non-drive side.

Torque to 30 in/lb.



14.

Slide the shock extender into the swingarm just below the dogbone. Orient the extender so the portion with female threads is below the non threaded portion of the extender.



17.

Apply blue loctite to the threads on the shock extender bolt. Tighten the bolt through the shock extender and shock with a 6mm allen key.

Torque to 95-100 in/lb.



18.

Install the front of the shock onto the frame. Insert a 34 mm Ti female bolt with a shock bolt washer through the drive side of the frame and shock. Use a Ti male bolt prepped with a washers and blue loctite on the nondrive side and tighten with two 5mm allen keys.

Torque to 90-95 in/lb.



15.

Grease the shaft of a 303 WC male pin and prep the threads with blue loctite. Insert the pin through the shock extender and into the female threads on the drive side of the swingarm, tightening with a 6mm allen key. Repeat the process for the non-drive side.

Torque to 175-180 in/lb.



16.

Orient the shock so that the piggyback is above the shock body and towards the front of the bike. Turn the shaft so that the face of the rebound dial is on the drive side of the frame and insert the shock into the opening in the shock extender.

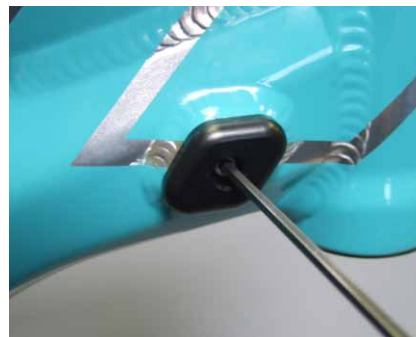

19.

Inset a fork bumper into the recess on the drive side of the frame. Prep a M4x8mm SHC bolt with blue loctite and tighten the bumper to the frame with a 3mm allen key. Repeat the process for the non-drive side.

Torque to 10-15 in/lb.



AXLE OPERATIONS



01.

Insert the threaded end of the axle through the frame and rear wheel from the non-drive side of the frame.



02.

Tighten the axle into the derailleur hanger with a 5mm allen key.

Torque to 40-45 in/lb.



03.

Tighten the M6x1x8mm SHC bolt into the M6 barrel insert with a 5mm allen key to secure the axle.

Torque to 40-45 in/lb.

EXPLODED VIEWS

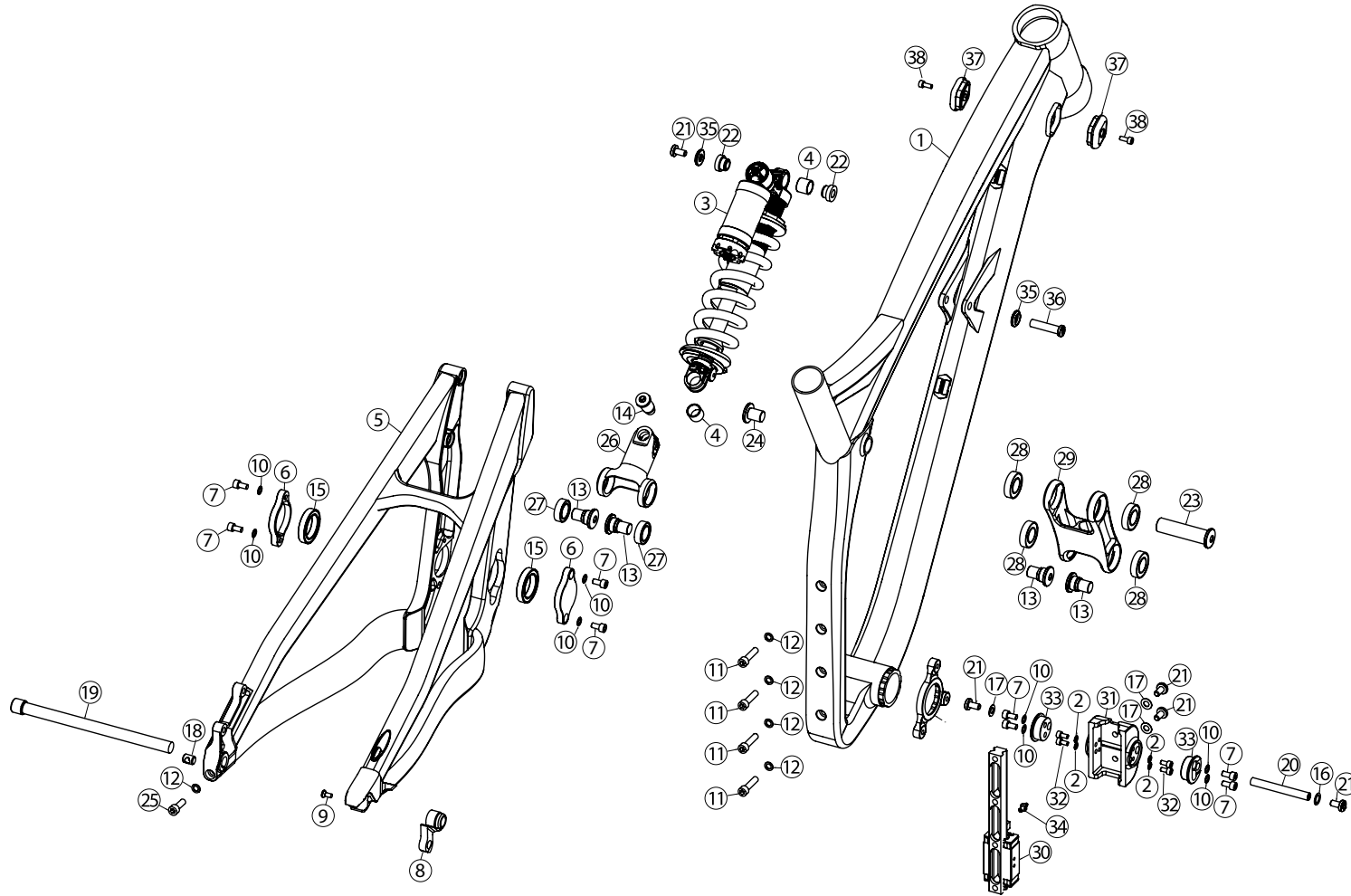

	DESCRIPTION	QTY
1	FRONT TRIANGLE 303 WC	1
2	WASHER (7.5X4.2X0.5MM)	4
3	FOX RC4 9.5X3.0	1
4	GARLOCK DP BUSHING .5"X.5"	2
5	REAR TRIANGLE 303 WC	1
6	BEARING CAP 303 WC	2
7	BOLT SHC M5X0.8X10MM	8
8	DERAILLEUR HANGER ASR7	1
9	BOLT FLAT M4X10MM	1
10	WASHER (5.5X9X0.5MM)	8
11	BOLT SHC M6X1X25MM	4
12	WASHER (9.85X6.2X1MM)	5
13	PIN MALE 303 WC M12X1.75	4
14	BOLT SHOCK EXTENDER 303 WC	1
15	BEARING 6805 2RS MAX	2
16	WASHER (8.5X12.5X0.5MM)	1
17	WASHER (6.5X12.5X0.5MM)	3
18	BARREL INSERT M6	1
19	AXLE 303 WC	1
20	STUD TI FEMALE M6X8X68MM	1
21	BOLT TI MALE M6X1X12MM	5
22	FOX REDUCER 8X22MM	2
23	303 WC DOGBONE PIN	1
24	303 WC DOGBONE PIN CAP	1
25	BOLT SHC M6X1X18MM	1
26	303 WC SHOCK EXTENDER	1
27	BEARING 3802 2RS MAX	2
28	BEARING 6902 2RS MAX	4
29	303 WC DOGBONE	1
30	303 WC THK GUIDE [170MM]	1
31	303 WC CAR MOUNT	1
32	BOLT SHC M4X8MM	4
33	303 WC MAIN PIVOT INSERT	2
34	HOSE BARB	1
35	WASHER SHOCK BOLT SB-66	2
36	BOLT TI FEMALE 8.0X34.0MM	1
37	303 WC BUMPER	2
38	BOLT BUTTON M4X0.7X10MM	2

REBUILD KITS

PART #	DESCRIPTION	QTY
H12WCDA0000000BRG0000	303 WC 2012 BEARING REBUILD KIT	1
300020038	BEARING 6805 2RS MAX	2
300020041	BEARING 3802 2RS MAX	2
300020042	BEARING 6902 2RS MAX	4
H12WCDA0000000MST0000	303 WC 2012 MASTER REBUILD KIT	1
300020038	BEARING 6805 2RS MAX	2
300020041	BEARING 3802 2RS MAX	2
300020042	BEARING 6902 2RS MAX	4
300030017	BOLT SHC M6X1X25	4
300030050	BOLT FLAT M4X10MM	1
300030062	WASHER (6.5X12.5X0.5MM)	3
300030069	WASHER (8.5X12.5X0.5MM)	3
300030110	BOLT TI MALE M6X1X12MM	5
300030111	BOLT TI FEMALE 8.0X34.0MM	1
300030119	BOLT SHC M5X.8X10	8
300030122	BOLT SHC M6X1X18	1
300030124	WASHER (5.5X9X0.5MM)	8
300030214	WASHER (9.85X6.2X1MM)	5
300030236	WASHER SHOCK BOLT SB-66	2
300040344	HOSE BARB	1
300040380	BARREL INSERT M6	1
HNA0000000M408BLT0000	BOLT SHC M4X7X8	4
HNA0000S007542WSH0000	WASHER (7.5X4.2X0.5MM)	4

HNA0000S00M668STD0000	STUD TI FEMALE M6X8X68MM	1
HNAWCDAABA0000PVT0000	303 WC DOGBONE PIN	1
HNAWCDAABA0000PVT0001	303 WC DOGBONE PIN CAP	1
HNAWCDAABAAA00SHX0000	303 WC SHOCK EXTENDER BOLT	1
HNAWCDAABAM217PVT0000	PIN MALE 303 WC M12X1.75	4

WARRANTY

YETI LIMITED (1) ONE YEAR FRAME WARRANTY

(applies to 303 WC / 4X / DJ)

Yeti Cycles will repair or replace, at its option, any frame it determines to be defective due to defective materials and/or workmanship. The (1) one year limited warranty is conditioned upon the bicycle being ridden under normal conditions and having been properly maintained. This warranty does not apply to the components attached to the frameset such as suspension components, wheels, drive train, brakes, seatpost, handlebar and stem. This warranty applies only to the original owner and is non-transferable. This warranty is void if the bicycle was not properly assembled by an authorized Yeti dealer.

YETI LIMITED (2) TWO YEAR FRAME WARRANTY

(applies to AS-R 5C / AS-R 5A / AS-R Carbon / SB66-A / SB66-C / SB95 / 575 / ARC / Big Top 29'R)

Yeti Cycles will repair or replace, at its option, any frame it determines to be defective due to defective materials and/or workmanship. The (2) two year limited warranty is conditioned upon the bicycle being ridden under normal conditions and having been properly maintained. This warranty does not apply to the components attached to the frameset such as suspension components, wheels, drive train, brakes, seatpost, handlebar and stem. This warranty applies only to the original owner and is non-transferable. This warranty is void if the bicycle was not properly assembled by an authorized Yeti dealer.

ADDITIONAL CONDITIONS

These limited warranties do not apply to normal wear and tear, nor to claimed defects, malfunctions or failures that result from abuse, neglect, improper assembly, improper maintenance, alteration, collision, crash or misuse. The original owner shall pay all labor charges connected with the repair or removal of all components. Under no circumstance does this limited warranty include the cost of travel or shipment to and from an authorized Yeti dealer. In order to exercise your rights under these limited warranties, the bicycle or frameset must be presented to an authorized Yeti dealer, together with proof of purchase.

**The above warranties have been in effect since January 2012. For warranty information on Yeti frames sold prior to that date please consult your local authorized dealer.*

NO FAULT REPLACEMENT POLICY

Yeti Cycles will make replacement parts available at a minimum charge to the original owner in the event of a crash or any other non-warranty situation. Yeti Cycles does this at its sole discretion and reserves the right to refuse this offer.

PRODUCT LIFE CYCLE

Every YETI frameset has a useful product life cycle. The length of that useful product life cycle will vary depending on the construction and the materials of the frameset, maintenance and care the frameset receives, and the amount and type of use the frameset is subjected to over its life. YETI recommends that an authorized YETI dealer should inspect the frame for stress annually. Frame stress could cause potential failure and the signs are usually apparent in the form of cracks, fracture lines, deformation, dents, and any other visual indicators of abnormality. These safety checks for frame stress are important to prevent accidents, injury to the cyclist, and product failure of a YETI frameset.

DISCLAIMER

YETI Cycles is not responsible for any damages to you or others arising from riding, transporting or other use of your bicycle. In the event that your frame breaks or malfunctions, YETI Cycles shall have no liability or obligation beyond the repair or replacement of your frame pursuant to the terms outlined in the warranty.

**If you have a warranty concern, please contact your authorized Yeti dealer.*

YETI CYCLES

600 Corporate Circle, Unit D
Golden, CO 80401
(p) 303-278-6909
(f) 303-278-6906
www.yeticycles.com

BUSINESS HOURS

Monday-Friday
8AM-11:30AM, 1:00PM-5:30PM
(Mountain Time)