

YETI

303 DH OWNER'S MANUAL '06-'07



YETI CYCLES
600 CORPORATE CIRCLE, UNIT D
GOLDEN, CO 80401
USA
303.278.6909 / 888.576.9384
www.yeticycles.com

Table of Contents

Brand Overview	4
Frame Features	6
Geometry	8
Maintenance Schedule	10
Bike Setup Overview	12
– Rail System Lubrication	14
– Eccentric Adjustment	16
– Shock Setup	18
– Shock Quick Start Guide	20
– Line Setup	22
Assembly Overview	24
– Assembly	26
Exploded Views	40
Part List	42
Warranty	44
Contact Information	45

Overview

WELCOME TO THE TRIBE

Congratulations on your purchase of a new Yeti bicycle and welcome to the Yeti Tribe. We are confident your new bicycle will exceed your expectations for value, performance, and ride quality. Each frameset and component has been custom specified and designed to enhance your riding experience. Whether you are a beginner cyclist, or a seasoned pro, Yeti bicycles will provide endless hours of two-wheeled fun.

GENERAL INFORMATION

This model specific manual is designed to be used in conjunction with the general Yeti Owner's Manual and the manuals supplied by the suspension manufactures. If you did not receive the Yeti owner's manual or the manual provided by the suspension manufacturer download the materials off the Internet, or contact your dealer.

Bicycling can be a hazardous activity even under the best of circumstances. Proper maintenance of your bicycle is your responsibility and when done properly helps reduce the risk of injury and damage to your bicycle. This manual outlines basic setup and maintenance recommendations of your new Yeti. Because it is impossible to anticipate every situation or condition that may occur during the assembly, setup, and maintenance of your bicycle, Yeti recommends that all service and repairs be

performed by an authorized Yeti Dealer.

This manual contains many "Warnings" and "Cautions" concerning the consequences of failure to maintain or inspect your bicycle. The combination of the safety alert symbol and the word "Warning" indicates a potentially hazardous situation in which, if not avoided, could result in serious injury or death. The combination of the safety alert symbol and the word "Caution" indicates a potentially hazardous situation in which, if not avoided may result in minor injuries or damage to your bicycle or a component of your bicycle. Be sure to read and understand all of the Warnings and Cautions.



Warning: Make sure you review and understand the warnings, instructions, and content of this manual and accompanying manuals for your bicycle.



Warning: Technological advances have made bicycles and bicycle components more complex and the pace of innovation is increasing. It is impossible for this manual or the accompanying manuals to provide all the information required to properly repair and/or maintain your bicycle. In order to help minimize the chances of an injury, it is critical for you to have work performed by an authorized Yeti retailer.



Frame Features

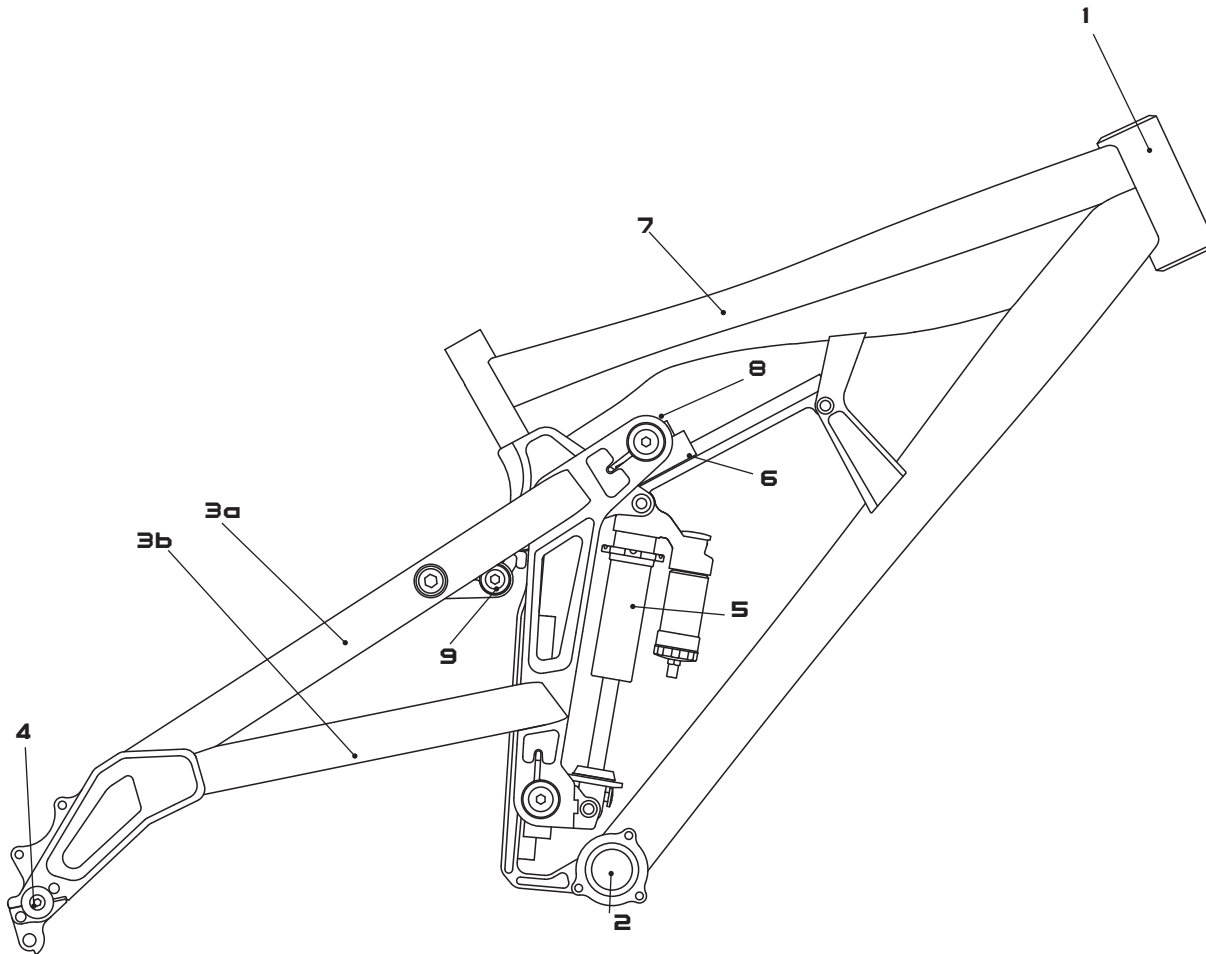

- PURE TUBING**
Yeti Pure tubing is custom butted and tapered 7005 aluminum. This makes the frame lightweight and strong without the use of gussets. Unique shape provides added strength at the head tube junctions.
- BOTTOM BRACKET**
83 mm shell, for use with a 128 mm spindle
- SEATSTAY (A) + CHAINSTAY (B)**
Square seatstays are stiff and strong. Elevated chainstays provide chainring clearance. Accommodates a 2.7" tire.
- THROUGH AXLE**
12/15mm through axel spaced at 150mm. Allows for a stiff and strong rear end.
- SHOCK**
9.5" eye-to-eye / 3.0" stroke.
- LINEAR RAIL SYSTEM**
The linear block contains four rows of ball bearings that circulate along the rail allowing the guide to move freely. The linear rail has an armalloy surface for corrosion protection and wear.
- MONOCOQUE TOP TUBE**
Boxed form allows for a stiff and light construction.
- ECCENTRIC MOUNT**
Eccentric mount allows for adjustable geometry. The head angle and bottom bracket height can be adjusted from 64°/14.0" to 66°/15.0".
- STABILIZING LINK**
Stabilizing link translates the rear wheel load directly into the main frame. Allowing the shock and rail system to function under less force.

Geometry

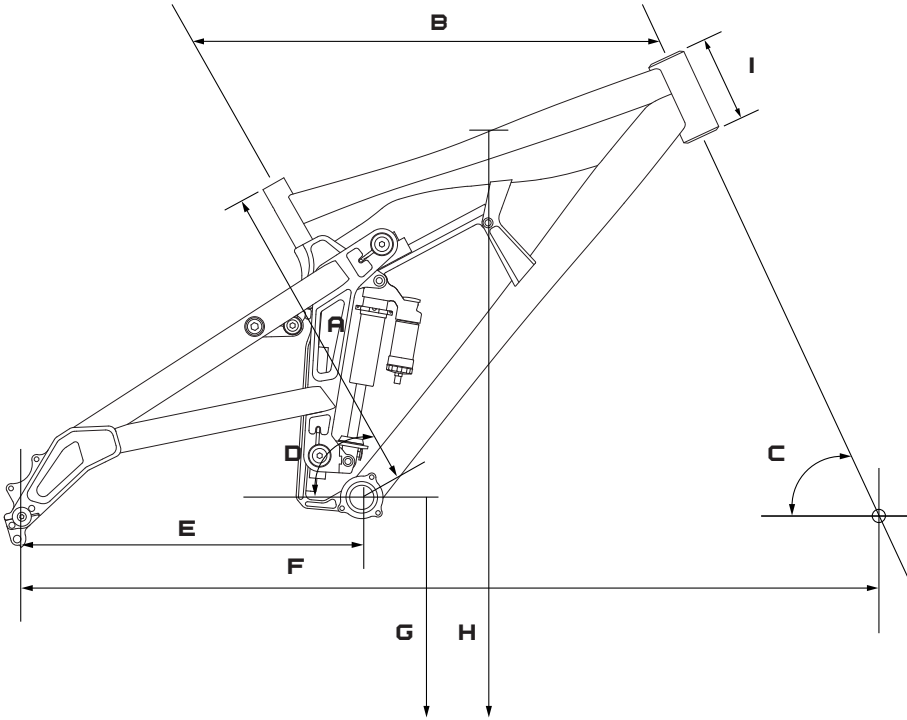

GEOMETRY 303 DH

	S	M	L
A	16.75	16.75	16.75
B	22.00	23.00	24.00
C	66-64	66-64	66-64
D	58	58	58
E	17.60	17.60	17.60
F	46.75-46.25	46.75-46.25	46.75-46.25
G	14.0-15.0	14.0-15.0	14.0-15.0
H	30.50-31.00	30.50-31.00	30.50-31.00
I	4.50	4.50	4.50

*All measurements are in inches

Maintenance



MAINTENANCE? Not sure how to work on your own bike? Contact your authorized Yeti dealer or visit www.parktool.com and check out the repair help section. This section contains detailed instruction on many of the service items listed in the maintenance schedule.

MAINTENANCE Following these guidelines will help maintain the performance of your bicycle and prevent more serious problems from arising. It is important to remember that service intervals can vary depending on climate, trail conditions, and riding frequency.

ACTION	EVERY RIDE	MONTHLY	3 MONTHS	ANNUALLY
Lube linear block (see page 14)	x			
Clean and lube chain	x			
Check tire pressure	x			
Clean bike of mud and debris (never spray water directly into frame or components)	x			
Check shock pressure	x			
Check for loose bolts and tighten if necessary	x			
Check headset and tighten/loosen if necessary		x		
Thoroughly clean pivot points with a rag (do not lubricate)		x		
Replace brake pads if necessary			x	
Check tires for wear			x	
Check spoke tension, and retention if necessary			x	
Check chain for worn, damaged, or loose links. Replace chain if necessary			x	
Complete tune-up performed by an authorized YETI dealer				x

TORQUE We have attached a brief list of torque specifications for bolts and components that may need to be tightened while performing basic maintenance. This is just guide. For specific torque specifications, please contact the component manufacturer directly.

TORQUE SPECS

Swingarm Pivot Pins	40 - 50
Stabilizer Pinch Bolts	40 - 50
Titanium Pivot Bolts	125 - 150
Pivot Pins	125 - 150
Through Axle Bolts	125 - 150
Cable Guide Screws	10 - 15
Derailleur Hanger Bolts	30 - 45
Handlebar Binder Bolt	150 - 180
Stem Binder Bolt	175 - 260
Seatpost Binder Bolt	150 - 180
Saddle Clamp Bolts	175 - 250
Rear Derailleur	70 - 86
Chainring Bolts	88 - 132



Caution: The torque specifications listed should be used as a guide when performing maintenance. Technological advances have made bicycles and bicycle components more complex, and the pace of innovation is increasing. Because of these advances, YETI recommends that you refer to the torque specifications of the manufactures component you are adjusting. In order to help minimize the chances of an injury, do not perform any maintenance that you are not confident can be completed within your abilities.

Bike Setup



TOOLS NEEDED

- Shock Pump
- Tape Measure
- 4mm allen key
- Lubrication Syringe
- White Lithium Grease
- 4mm allen key
- 5mm allen key
- 1.5mm allen key

TIME

30-45 minutes

YETI TIPS

- Inspect your shock for any visible damage. If oil is leaking or you notice any damage to the surfaces or seals, please contact the Fox Racing Shox service center for repair.
- Removing the shock from the linkage will require the Yeti linkage tool for proper assembly and disassembly. The tool can be purchased online www.yeticycles.com or through an authorized YETI dealer.



Rail System Lubrication

SETUP OVERVIEW Both the rail and block are made from proprietary carbon steel. The rail is then case hardened to between 58 and 64Rc. An Armalloy surface treatment is applied to the rail and the block for corrosion protection and wear resistance. The ball bearings are made from martensitic stainless steel - which is equal to a 440 stainless. End scrapers, end seals, inner seals, and side seals prevent contaminants from entering the system.

There is also a custom grease port on the end of each block. Grease should be applied with the supplied applicator after the days ride and/or bike wash. After grease application, the suspension needs to be cycled 6-10 times to spread the grease evenly throughout the bearing raceways and ports in the block.

1 RAIL LUBRICATION Fill the supplied syringe with white lithium grease. This is best done by removing the plunger on the syringe and packing it with the grease. Once the syringe is filled, press the end of the rubber line onto the grease port as shown. Compress the syringe to force grease into the rail system.



Warning: The rails system must be lubricated after every ride. Failure to lubricate based on the specifications can cause permanent damage to the linear rail.

1 RAIL LUBRICATION After you have completed the initial lubrication. Weight and unweight the bike to compress the shock and actuate the rail system. If you see residual grease left on the rail after cycling the suspension you have sufficiently lubricated the system. If no grease is visible after cycling repeat Step 1 until residual grease is visible on the rail after cycling. Perform this lubrication for both the top and main rail systems. Wipe off any excess grease on the rail before riding. 🇪🇺

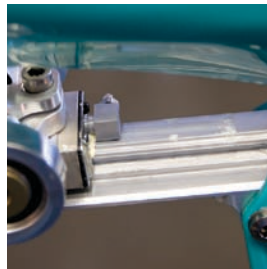

Eccentric Adjustment

SETUP OVERVIEW The 303 DH has the ability to change the geometry of the bike via the eccentric mount. The geometry can be adjusted from a 64 degree head angle / 14 inch bottom bracket height through a 66 degree head angle / 15 inch bottom bracket height.

1 ECCENTRIC ADJUSTMENT Slightly loosen the eccentric mount bolts with a 5mm allen key. The bolts only need to be just loose enough to spin the Eccentric.



2 ECCENTRIC ADJUSTMENT Place a 6mm allen key into the pivot pin as shown. Rotate the eccentric to the desired position. The eccentric adjustment has a range of 64°/14" - 66°/15".

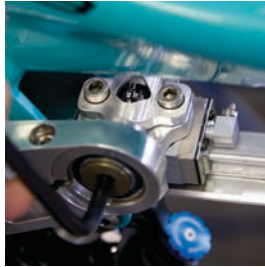

3 ECCENTRIC ADJUSTMENT Once the eccentric mount is in the desired position secure the mounting bolts. 🇪🇸



Torque: 125-150 inch/lbs

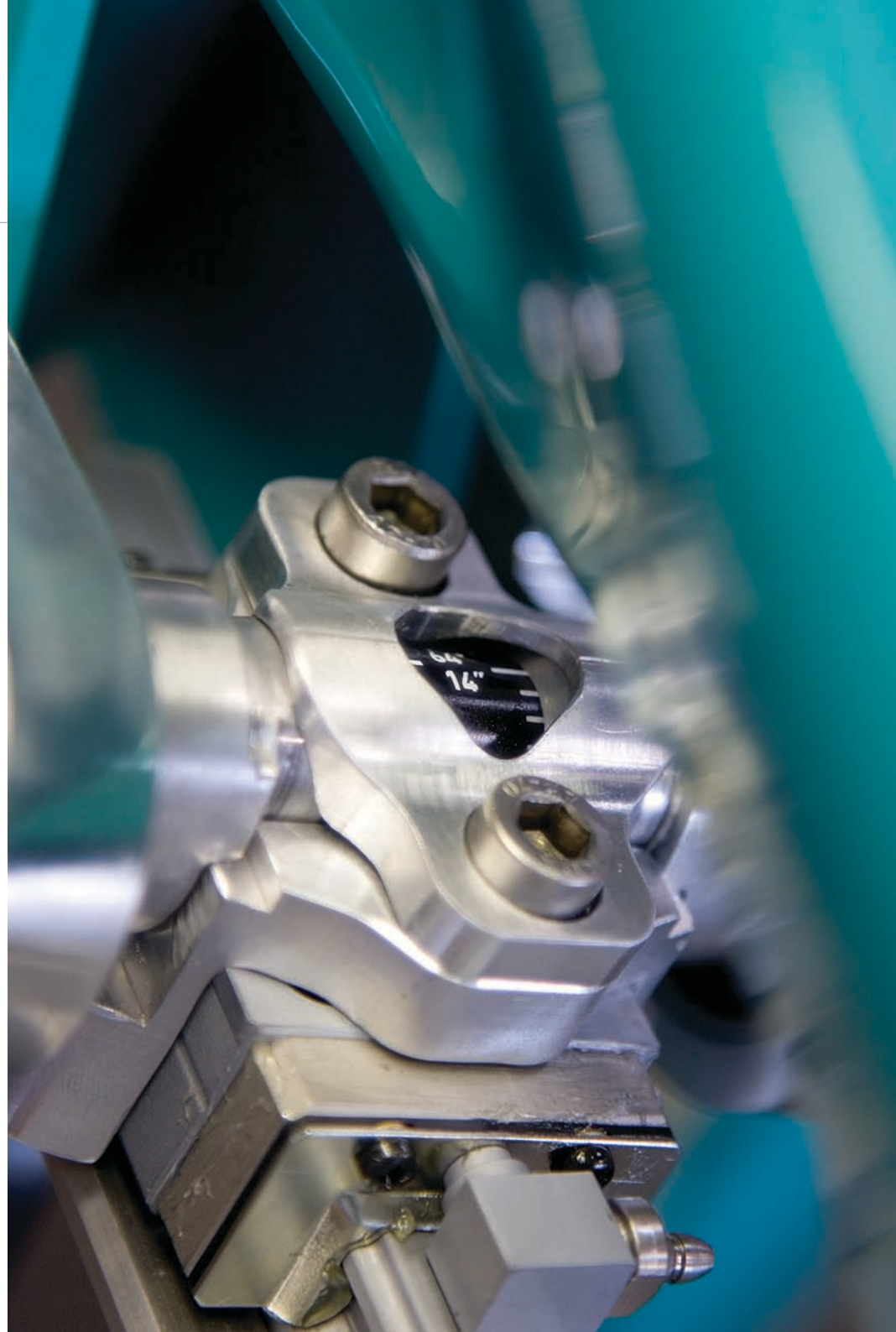

Shock Setup



WHAT IS PRO-PEDAL? Pro-Pedal is compression tune that gives the right amount of low speed compression to filter out unwanted rider induced bob without sacrificing critical mid and high speed damping. No flushing through your travel, no wasted setup time, and no energy sucking suspension movement, just super efficient pedaling performance ready for hits of any size.

SETUP OVERVIEW The DHX 5.0 employs both speed sensitive rebound damping and position sensitive compression damping. There are three external adjustments that affect the compression and one external adjustment for the rebound. The three compression adjustments are the Bottom-Out Resistance, Boost Valve and Pro-Pedal. The Pro-Pedal controls the anti-bob properties of the shock or the first part of the shocks stroke, the Bottom-Out Resistance affects the end of the shocks stroke, and the Boost Valve damping links these two adjustments together to create a seamless transition through the entire stroke. The Boost Valve also de-couples the Pro-Pedal and Bottom-Out Resistance making these adjustments independent on each other.

1 BOTTOM-OUT RESISTANCE The bottom-out adjuster has 3 full turns of adjustment. This adjustment controls the bottoming resistance of the shock, meaning it controls the compression on final part of the shocks stroke. The adjuster can be turned by hand or with a 4mm allen key. The allen key should be placed into one of the holes on the perimeter of the adjuster.

More Resistance - clockwise rotation
Less Resistance - counter-clockwise rotation

Warning: When the volume adjuster has reached its counter-clockwise stop limit, continued force on the adjuster may cause damage to the adjuster mechanism.

2 BOOST VALVE The DHX 5.0 has an air pressure range of 75-200 psi, and it must be pressurized. The Boost Valve allows the Pro-Pedal (beginning compression) and the Bottom-Out Resistance (ending compression) to work seamlessly together. Because of this relationship the Boost Valve pressure affects both the Bottom-Out Resistance and the Pro-Pedal Adjustments (see adjustment relation).

Lower pressures (75-100 psi) - will decrease bottoming resistance and Pro-Pedal at a given setting.

Higher pressures (110-200 psi) - will increase bottoming resistance and Pro-Pedal at a given setting

Warning: Use of the shock with improper air pressure can cause a loss of dampening and shock malfunction could occur. Do not attempt to turn the adjuster with more than 125 psi in the chamber..



3 PRO-PEDAL The Pro-Pedal adjustment has a 15 click range of adjustment. The Pro-Pedal damping affects the first half of stroke.

More Damping - clockwise rotation
Less Damping - counter-clockwise rotation

4 SAG SETUP Use 25-35% of the shocks stoke for downhill use. To determine sag, first measure the distance between the centers of each shock mounting bolt (eye-to-eye) and record this number. Make sure you have the correct spring for your weight. See the spring rate chart. >2006 303 DH eye-to-eye 9.5"

5 SAG SETUP Next, sit on the bike and record the new (eye-to-eye) measurement. Subtract the static eye-to-eye measurement from this new measurement and you get your sag in inches. An easy way to calculate sag is to multiply the shock travel by your desired sag percentage. See quick setup guide on page 20.

6 REBOUND The rebound adjustment has a 14-click range. Adjustments that are too fast (counter-clockwise adjustment) will produce a springy ride with excessive kick up of the rear end causing a bucking sensation. Adjustments that are too slow (clockwise adjustment) will cause packing of the rear wheel that is identified by a sluggish ride feeling.

Slower rebound - turn the adjuster clockwise
Faster rebound - turn the adjuster counter-clockwise



Quick Setup Guide

QUICK START GUIDE DHX 5.0 303 DH

Rebound	10 Clicks
Bottom-Out Resistance	1 Turn
Pro-Pedal	2 Clicks
Boost Valve	125 psi

SAG SETTINGS

Sag %	25	30	35
Eye-To-Eye (inches)	8.750"	8.600"	7.95"

*All Clicks are clockwise rotation from all the way out or a full counter-clockwise position.

SPRING WEIGHTS - RECOMMENDED 303 DH

SPRING CHART (IN/LBS)	400	450	500	550	600
Min. rider weight (lbs)	125	130	150	205	245
Max. rider weight (lbs)	150	190	215	250	275



Line Setup

SETUP OVERVIEW The 303 DH has full cable housing. Utilizing full cable housing helps prevent corrosion from the elements and keeps the shifting smoother for a longer period of time. The 303 DH also has custom guides that allows the cables to slide when the bike is compressed.

Caution: The failure to properly route shifter housing can cause malfunction of the shift mechanism and unexpected shifting of gears

1 LINE SETUP The first step in the rear derailleur line setup is to cut the proper length housing. The housing runs from the rear shifter along the drive side of the bike, down the seatstay, and into the derailleur stop. If the housing is too long it will sag and rub on the lower crown of the fork



2 LINE SETUP Once you have the proper length housing install the IGUS | Glide Clips as shown. The flange of each clip should be placed on the end of the cable guide.



3 LINE SETUP Install the top cable guide and screw the M2.5x.45x.8 flat head bolt using a 1.5mm allen key. Repeat this process on the opposing side for the rear brake. 



Torque: 10-15 inch/lbs

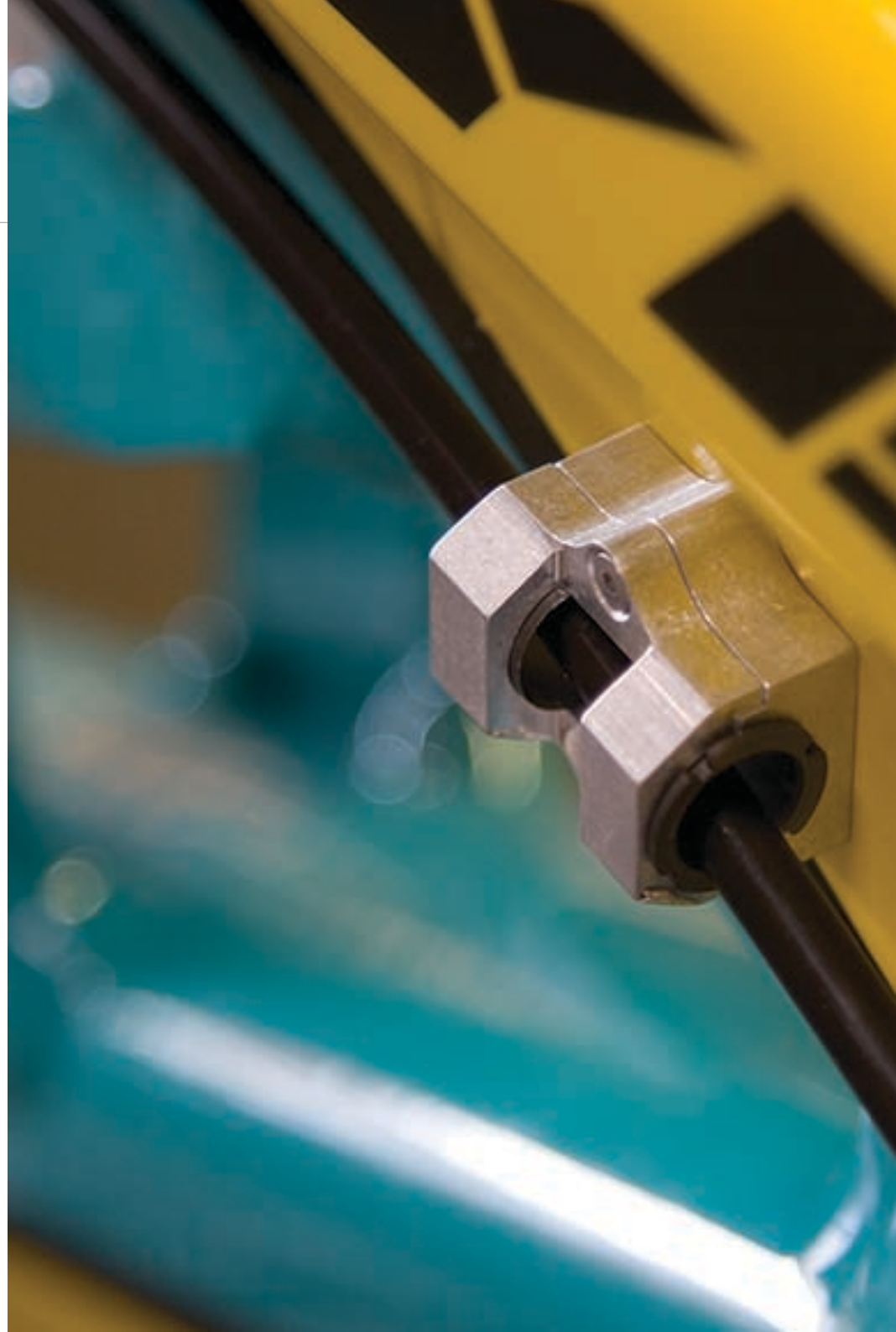

Assembly



TOOLS NEEDED

- Dead blow hammer
- 14mm socket
- Two - 5mm allen keys
- 6mm allen key
- 4mm allen key
- 3mm allen key
- 8mm allen key
- White Lithium Grease
- Blue Loctite
- Ti Prep

TIME

30-45 minutes depending on condition of the bike

YETI TIPS

- Make sure your tools are in good condition. A worn allen key can round the hex on a bolt not allowing for proper torque.
 - Torque settings are listed throughout the instructions. It is also important to prep all bolt threads. The instructions denote whether to use a blue Loctite compound or grease.
 - The linkage tool is necessary to properly disassemble and reassemble the linkage. Using a hammer to tap out the pin can cause damage to the linkage and shock.
 - Not every tool may be needed for the assembly/disassembly of your bike. The list encompasses all the tools necessary to complete assembly/disassembly on each bike.
- Warning:** Service on Yeti bicycles requires special knowledge and tools. Yeti Cycles recommends that all service and repairs be performed by an authorized Yeti Dealer



Sub Assembly

- 1 TOP RAIL SUBASSEMBLY** Place the rail system onto the Top Rail Mount as shown.

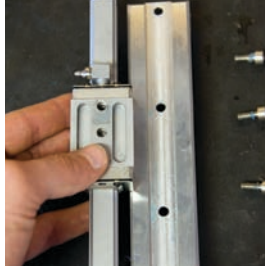

- 2 TOP RAIL SUBASSEMBLY** Make sure the grease port is at the opposite end the square opening of the Top Rail Mount as shown.

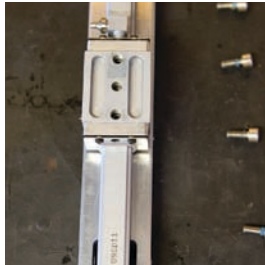

- 3 TOP RAIL SUBASSEMBLY** Apply loctite to the four M5x.8x12 socket caphead mounting bolts.



- 4 TOP RAIL SUBASSEMBLY** Screw all four of the bolts into the rail using a 4mm allen key.

Torque: 125-150 inch/lbs

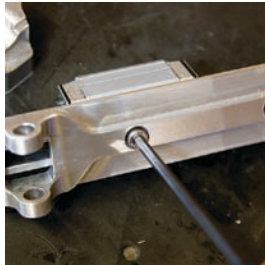

- 5 TOP RAIL SUBASSEMBLY** Place the Eccentric Base onto the Linear Block. Make sure to place the shorter tab of the Eccentric Base towards the grease port as shown.

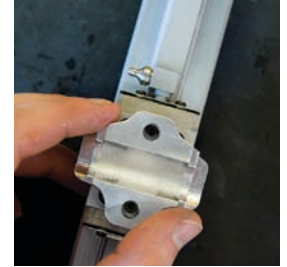

- 6 TOP RAIL SUBASSEMBLY** Place the Eccentric on the Eccentric Base. Make sure you position the stops as shown.



- 7 TOP RAIL SUBASSEMBLY** Place the Eccentric Clamp onto the Eccentric. Apply loctite to the four 6x1x18mm socket caphead mounting bolts, and tighten them into the Eccentric Base using a 5mm allen key.

Torque: 125-150 inch/lbs

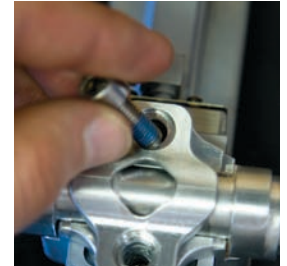

- 8 MAIN RAIL SUBASSEMBLY** Place the Main Pivot Mount onto the rail as shown. Make sure the threaded mount is positioned away from the grease port. Apply loctite to the two M6x1x8 button caphead bolts and tighten down using a 4mm allen key.

Torque: 125-150 inch/lbs

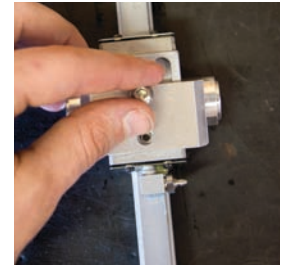



TI PREP Yeti recommends prepping all titanium threads with ti prep.

Sub Assembly Cont.

- 9 STABILIZING LINK SUBASSEMBLY** Place the 38802 2RS Max Bearings into the Stiff Link H as shown. Make sure the extended race of the bearings points inward. Repeat on the opposing side



- 10 STABILIZING LINK SUBASSEMBLY** Place the Stiff Link I between the bearings. Slide the 12mm x 42mm Pivot Pin through the bearings and the Stiff Link I. Screw the M5x.8x10 socket caphead mounting bolts into the Stiff Link I, do not torque the bolts. The torque application will take place at a later step.

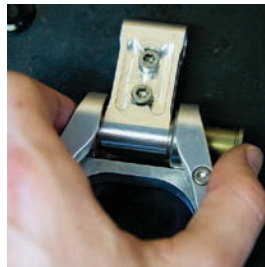

- 11 STABILIZING LINK SUBASSEMBLY** Apply ti prep to the M6x1x12 Ti Male Bolt.

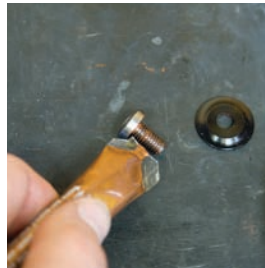

- 12 STABILIZING LINK SUBASSEMBLY** Attach the Ti Male Bolt and Pivot Pin Washer to the 12mm x 42mm Pivot Pin and tighten using a 5mm and 6mm allen keys.

Torque spec: 125-150 inch/pounds.



- 13 STABILIZING LINK SUBASSEMBLY** Place the 38802 2RS Max Bearings into the tail of the Stiff Link H, make sure the extended race is pointing outwards. Slide the 12.7mm x 7mm Pivot Pins into the bearings as shown. Screw the M4x.7x16 socket caphead mounting bolts into the link. Just torque lightly so the bearing and pin assembly does not fall out of the link. The final torque application will take place at a later step.

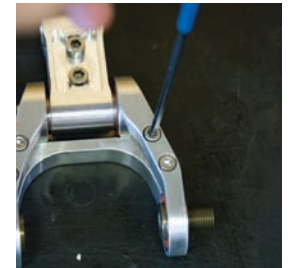

- 14 SHOCK LINK SUBASSEMBLY** Place the Shock Mount onto the lower end of the shock as shown. Slide the 8mm x31.75mm Ti Female Bolt and 8.5mmID x 12.5mmOD washer through the shock mount and shock eyelet.



- 15 SHOCK LINK SUBASSEMBLY** Apply ti prep to the M6x1x12 Ti Male Bolt.

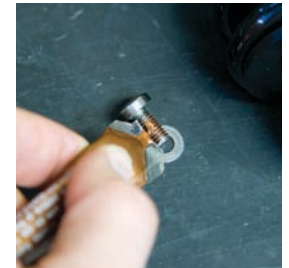

- 16 SHOCK LINK SUBASSEMBLY** Attach the M6x1x12 Ti Male Bolt and 6.5mmID x 12.5mmOD washer to the female bolt and tighten using two 5mm allen keys. Don not fully torque the complete torque will take place at a later step.



Main Assembly

17 MAIN ASSEMBLY Take the Top Rail sub assembly with the grease port pointing towards the non-drive side of the frame and tap the back of the sub assembly into the rear mount.



18 MAIN ASSEMBLY Line up the through holes on the frame and rail mount and slide the 8mm x44mm Solid Ti Female Bolt and 8.5mmID x 2.5mmOD washer through the assembly. Do not attach the opposing male bolt, the female bolt stays in this configuration only temporarily until a later step.

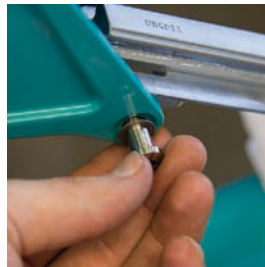

19 MAIN ASSEMBLY Swing the front of the Top Rail subassembly into position on the front mount.



20 MAIN ASSEMBLY Lineup the through holes and slide the 8mm x 44mm Ti Female Bolt and 8.5mmID x 12.5mm OD washer into the frame and rail mount.

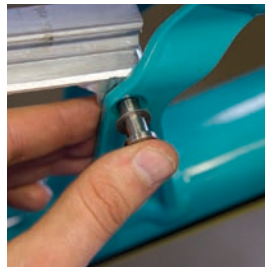

21 MAIN ASSEMBLY Apply ti prep to the M6x1x12 Ti Male Bolt. Slide the 6.5mmID x 12.5mmOD washer onto the bolt and tighten using two 5mm allen keys.

Torque spec: 125-150 inch/pounds.

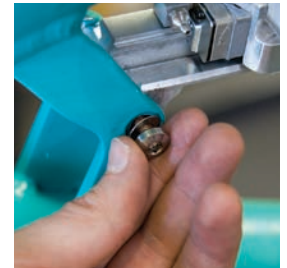

22 MAIN ASSEMBLY Place the Main Rail subassembly onto the frame as shown.



23 MAIN ASSEMBLY Attach the Main Rail subassembly to the frame with the M5x.8x16 socket caphead bolts. Tighten using a 4mm allen key. Make sure you prep the bolts with loctite.

Torque spec: 125-150 inch/pounds.

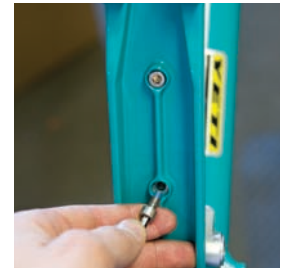

24 MAIN ASSEMBLY Screw the M5x.8x14 socket cap head bolts into the frame as shown. Don not torque the bolts down, that will take place at a later step. ▶



Main Assembly Cont.

25 MAIN ASSEMBLY Tap the 38802 2RS Max Bearings into the frame as shown with the dead blow hammer. Make sure the extended race is pointing inward.

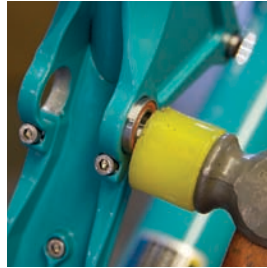

26 MAIN ASSEMBLY Tap the bearings with the 14mm socket to slightly recess them into the frame.

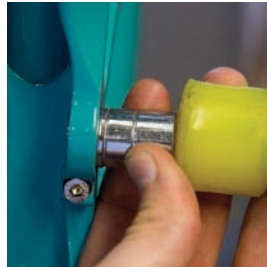

27 MAIN ASSEMBLY The bearings should be positioned as shown for proper alignment.



28 MAIN ASSEMBLY Align the Stabilizing Link subassembly in to position between the bearings as shown. Tap the 12.7mm x 42mm Pivot Pin through the bearings and the link.



29 MAIN ASSEMBLY Apply ti prep to the M6x12 Ti Male Bolt. Screw the bolt and washer onto the pin as shown and tighten using a 5mm and 6mm allen keys.

Torque spec: 125-150 inch/pounds.



30 MAIN ASSEMBLY Lubricate the 17mm x 7.5mm Pivot Pin.



31 MAIN ASSEMBLY Tap the lubricated pivot pin into the frame with a dead blow hammer. Repeat this process for the second bearing mount on the swingarm.



32 MAIN ASSEMBLY Screw the pivot pin into the eccentric using a 5mm allen key, stop once you have a few threads started. Then proceed to the lower bearing mount. ▶



Main Assembly Cont.

33 MAIN ASSEMBLY Screw the pivot pin in a few turns, and then return to the upper pivot mount and make a few turns. Repeat this back and forth process until the swingarm is fully secure. Repeat this process for the opposing side.

Torque spec: 40-50 inch/pounds.



34 MAIN ASSEMBLY Lubricate the through holes on the swingarm.



35 MAIN ASSEMBLY Place the Swingarm Spacer - Stiff Link onto the pivot pin and lubricate the threads of the pivot pin.



36 MAIN ASSEMBLY Loosen the bolts on the Stiff Link H to release the bearing and pivot pin. Rotate the link into position so the through holes line up and slide the bearing, washer, and pivot pin in the through hole. Making sure to keep the bearing flush with the face of the Stiff Link H.



37 MAIN ASSEMBLY Slide the Swingarm Insert - Stiff Link through the swingarm bore.



38 MAIN ASSEMBLY Tighten the pivot pin together using the 6mm and 8mm allen keys.

Torque spec: 40-50 inch/pounds.



39 MAIN ASSEMBLY Push the solid ti bolt out of the rail mount and frame. Place the shock subassembly into position as shown and slide the solid ti bolt back into position through the frame, rail mount, and shock.



40 MAIN ASSEMBLY Screw a M6x1x12 Ti Male Bolt and 6.5mmID x 12.5mmOD, into the bolt and tighten using two 5mm allen keys. ▶

Torque spec: 125-150 inch/pounds.



Main Assembly Cont.

41 MAIN ASSEMBLY Secure the lower shock mount to the swingarm using the M5x.8x12 and M5x.8x14 socket cap head bolts. The shorter of the two bolts the M5x.8x12 is used for the upper mounting hole and M5x.8x14 is used for the lower mounting holes. Remember to use loctite on the threads and tighten using a 4mm allen key.

Torque spec: 125-150 inch/pounds.

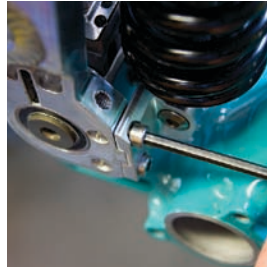

42 MAIN ASSEMBLY Now you can fully torque the lower shock mount bolt that was only temporarily secured from the shock subassembly. Use two 5mm allen keys to tighten.

Torque spec: 125-150 inch/pounds.

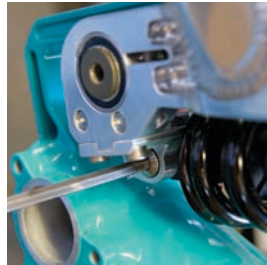

43 MAIN ASSEMBLY Slide the Axle Insert in the outside face of the rear drops as shown, Make sure the flanged end of the insert is facing outwards. Repeat for the opposing side.



44 MAIN ASSEMBLY Screw M6x1x12 Ti Male Bolt and Axle Cap onto the 12mm x 150mm Axle. Make sure to apply ti prep to the threads.

Torque spec: 125-150 inch/pounds.

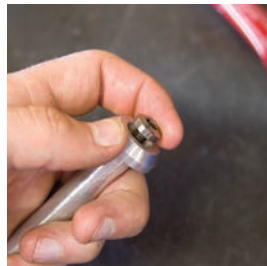

45 MAIN ASSEMBLY Slide the axle subassembly into the frame as shown. Use either your wheel or the spacing tube shipped with the frame as the 150mm rear wheel spacing.

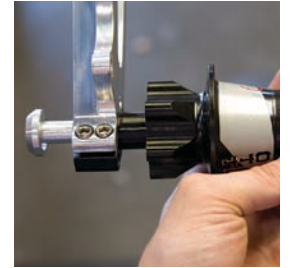

46 MAIN ASSEMBLY Screw M6x1x12 Ti Male Bolt and Axle Cap onto the axle. Make sure to apply ti prep to the threads.



47 MAIN ASSEMBLY Use two 5mm allen keys and tighten the axle down.

Torque spec: 125-150 inch/pounds.

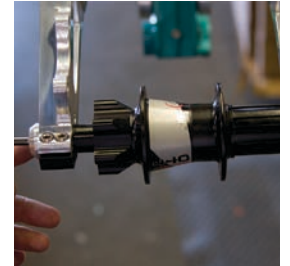

48 MAIN ASSEMBLY Tighten the pinch bolts on the dropouts using a 5mm allen key. Repeat for the opposing side. ▶

Torque spec: 125-150 inch/pounds.

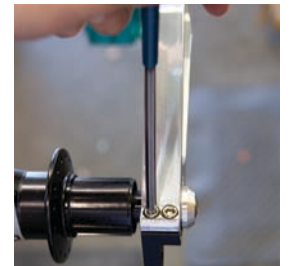

Main Assembly Cont.

49 MAIN ASSEMBLY After the axle is secure and the rear spacing is 150mm, you can tighten the pinch bolts on the Stabilizing Link. Start with the bolts on the main frame. Make sure the link is centered between the bearings and the frame and tighten using a 4mm allen key.

Torque spec: 40-50 inch/pounds.

Warning: This step should only take place once the axle is secured and the rear wheel spacing is 150mm

50 MAIN ASSEMBLY Next, tighten the bolts on the Stiff Link I using a 4mm allen key.

Torque spec: 40-50 inch/pounds.

Warning: This step should only take place once the axle is secured and the rear wheel spacing is 150mm

51 MAIN ASSEMBLY The final bolts to secure on the link are the Stiff Link H pinch bolts. Make sure that the tail ends of Stiff Link H are centered the bearings as shown before tightening.

Warning: The Stiff Link H must be centered over the bearings of the stabilizing link may not function properly.

52 MAIN ASSEMBLY Once the Stiff Link H is centered, tighten the pinch bolts using a 3mm allen key.

Torque spec: 40-50 inch/pounds.

Warning: This step should only take place once the axle is secured and the rear wheel spacing is 150mm

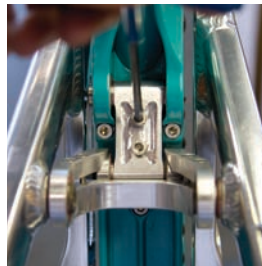

53 MAIN ASSEMBLY The final steps are to tighten the pinch bolts on the swingarm. Locate the bolts near the bearings and secure using a 5mm allen key.



54 MAIN ASSEMBLY Repeat this step for both locations and the opposing swingarm. 🇪🇺

Torque spec: 125-150 inch/pounds.



Exploded Views



REBUILD KITS The individual components of each Yeti bike are not sold separately. All yeti parts are sold in rebuild kits listed below. Each and every part can be obtained by purchasing one of the rebuild kits. Cross reference the part number you desire from the parts list to the rebuild list.

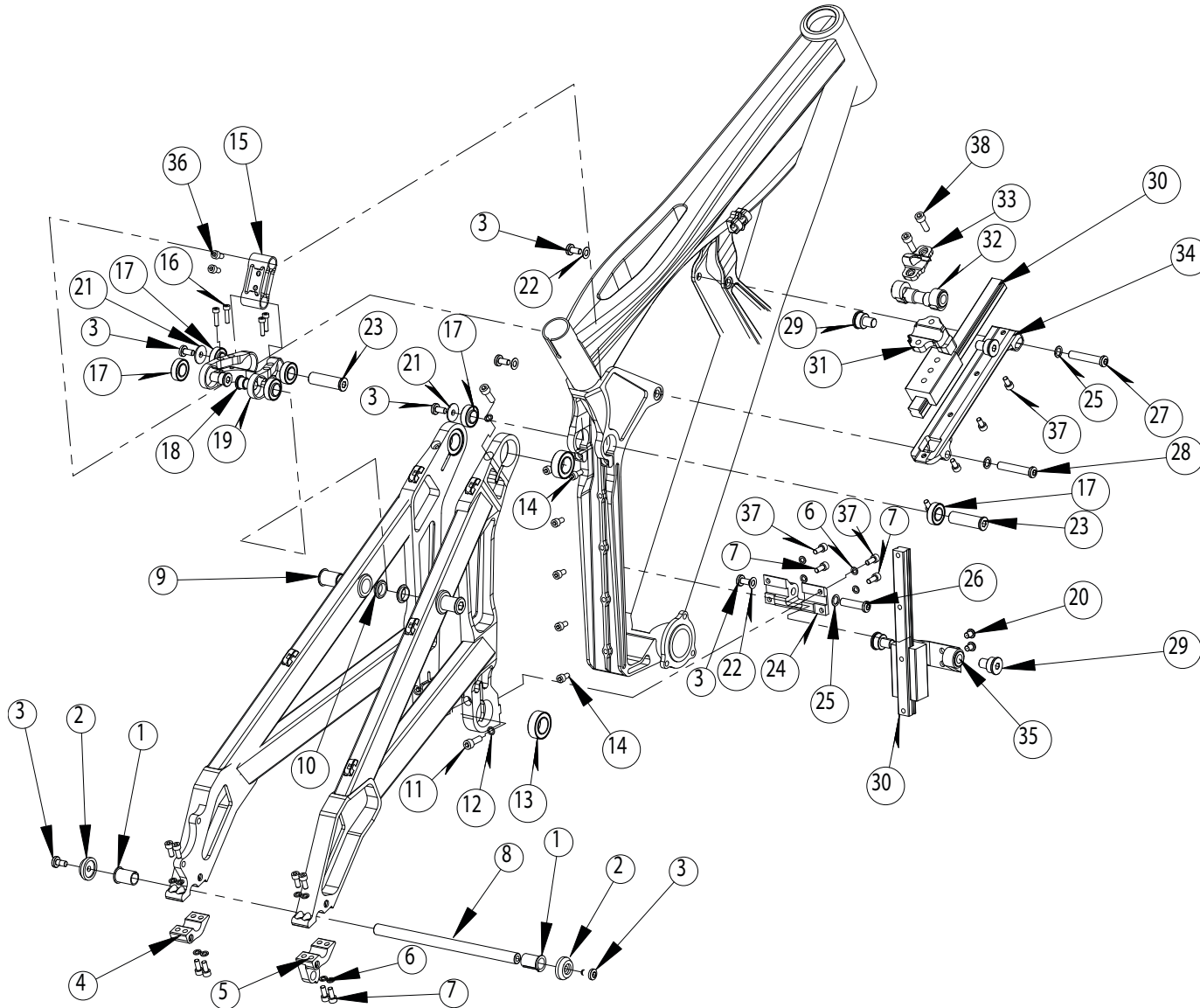

PARTS LIST

QTY.	PART #	DESCRIPTION
1	2	300040342 Axle insert 12mm x15mm
2	2	300040343 Axle Cap
3	5	300030110 Bolt Ti Male 6x1x12mm
4	1	300040350 Axle Clamp
5	1	300040346 Derailleur Hanger
6	12	300030124 Waher 5.5mm ID x 9mm OD
7	6	300030123 Bolt Cap Skt HD M5x.8x14
8	1	300040341 Axle 150x12mm
9	2	300040347 Swingarm Insert - Stiff Link
10	2	300040348 Swingarm Spacer - Stiff Link
11	4	300030017 Bolt Cap Skt HD M6x1x25
12	2	300030072 Washer 6mm ID x 9mm OD
13	4	300020030 Bearing 3903 2rs Double R
14	6	300030010 Bolt Cap Skt HD M5x.8x16
15	1	300040339 Stiff Link I
16	4	300030120 Bolt Cap Skt HD M4x.7x16
17	6	300020031 Bearing 38802 2rs Max
18	2	300030184 Pivot Pin Male 12.7mm x 7mm
19	1	300040340 Stiff Link H
20	2	300030117 Bolt Button Cap HD M6x1x8
21	2	300030179 Washer Custom Pivot Pin
22	3	300030062 Washer 6.5mm ID x 12.5mm OD
23	2	300030183 Pivot Pin Male 12.7mm x 42mm
24	1	300040338 Shock Mount
25	8	300030069 Washer 8.5mm ID x 12.5mm OD
26	1	300030109 Bolt Ti Feamble 8mm x 44mm
27	1	300030108 Bolt Ti Feamble 8mm x 31.75mm
28	1	300030113 Bolt Ti Female 8mm x 44mm SOL
29	4	300030185 Pivot Pin Male 17mm x 7.5mm
30	2	300040229 HSR15 LM Guide
31	1	300040336 Eccentric Base
32	1	300040334 Eccentric
33	1	300040335 Eccentric Clamp
34	1	300040333 Rail Mount Top
35	1	300040337 Main Pivot Mount
36	2	300030119 Bolt Cap Skt HD M5x.8x10
37	6	300030011 Bolt Cap Skt HD M5x.8x12
38	2	300030122 Bolt Cap Skt HD M6x1x18

Rebuild Kits

Rebuild Kits

PART NUMBER	DESCRIPTION	QTY.
200020091	303 DH BEARING REBUILD KIT '06	1
	300020030 BEARING 3903 2RS DOUBLE R	4
	300020031 BEARING 38802 2RS MAX	6
200020092	303 DH MASTER REBUILD KIT '06	1
	300020030 BEARING 3903 2 RS DOUBLE R	4
	300020031 BEARING 38802 2RS MAX	6
	300020033 IGUS I-GLIDE CLIP	2
	300030119 BOLT CAP SCKT M5X.8X10	2
	300030011 BOLT CAP SCKT M5X.8X12	6
	300030123 BOLT CAP SCKT M5X.8X14	6
	300030010 BOLT CAP SCKT M5X.8X16	6
	300030122 BOLT CAP SCKT M6X1X18	2
	300030017 BOLT CAP SCKT M6X1X25	4
	300030120 BOLT CAP SCKT M4X.7X16	4
	300030117 BOLT BUTTON HD CAP M6X1X8	2
	300030122 BOLT FLAT HD M2.5X.45X8	4
	300030108 BOLT-TI FEMALE 8.0X31.75MM	1
	300030109 BOLT-TI FEMALE 8.0X44.0MM	1
	300030110 BOLT-TI MALE M6X1X12	5
	300030113 BOLT-TI FEMALE 8.0X44.0MM SOL	1
	300030124 WASHER SS 5.5MM ID X 9MM OD	12
	300030072 WASHER SS 6MM ID 9MM OD	2
	300030062 WASHER SS 6.5MM ID 12.5MM OD	3
	300030069 WASHER SS 8.5MM ID 12.5MM OD	8
	300030179 WASHER PIVOT PIN	2
	300030183 PIVOT PIN 12.7MMX42MM	2
	300030184 PIVOT PIN - MALE 12.7MMX7.5MM	4
	300030185 PIVOT PIN - MALE 12.7MMX7MM	2
	300040347 SWINGARM INSERT - STIFF LINK	2
	300040348 SWINGARM SPACER - STIFF LINK	3
200020093	303 DH 12MM AXLE KIT '06	1
	300030110 BOLT TI - MALE M6X1X12	2
	300040341 AXLE 150X12MM	1
	300040342 AXLE INSERT 12X15MM	2
	300040343 AXLE CAP	2

PART NUMBER	DESCRIPTION	QTY.
200020094	303 DH CABLE GUIDE KIT '06	1
	300020033 IGUS I-GLIDE CLIP	4
	300030121 BOLT FLAT HD M2.5X.45X8	4
	300040331 CABLE GUIDE BOTTOM	2
	300030332 CABLE GUIDE TOP	2

Warranty

YETI LIMITED (2) TWO YEAR FRAME WARRANTY (applies to 303 DH, DH-9, AS-X, 4X, DJ)

Yeti Cycles will repair or replace, at its option, any frame it determines to be defective due to defective materials and/or workmanship. The (2) two year limited warranty is conditioned upon the bicycle being ridden under normal conditions and having been properly maintained. This warranty does not apply to the components attached to the frameset such as suspension components, wheels, drive train, brakes, seatpost, handlebar and stem. This warranty applies only to the original owner and is non-transferable. This warranty is void if the bicycle was not properly assembled by an authorized Yeti dealer.

YETI LIMITED (5) FIVE YEAR FRAME WARRANTY (applies to AS-R-sl, AS-R, 575, ARC, FRO, Kokopelli)

Yeti Cycles will repair or replace, at its option, any frame it determines to be defective due to defective materials and/or workmanship. The (5) five year limited warranty is conditioned upon the bicycle being ridden under normal conditions and having been properly maintained. This warranty does not apply to the components attached to the frameset such as suspension components, wheels, drive train, brakes, seatpost, handlebar and stem. This warranty applies only to the original owner and is non-transferable. This warranty is void if the bicycle was not properly assembled by an authorized Yeti dealer.

ADDITIONAL CONDITIONS

These limited warranties do not apply to normal wear and tear, nor to claimed defects, malfunctions or failures that result from abuse, neglect, improper assembly, improper maintenance, alteration, collision, crash or misuse. The original owner shall pay all labor charges connected with the repair or removal of all components. Under no circumstance does this limited warranty include the cost of travel or shipment to and from an authorized Yeti dealer. In order to exercise your rights under these limited warranties, the bicycle or frameset must be presented to an authorized Yeti dealer, together with proof of purchase.

- The above warranties have been in effect since January 2000. All Yeti frames sold prior to that date had a limited (1) one year warranty on the frameset.
- No Fault Replacement Policy
- Yeti Cycles will make replacement parts available at a minimum charge to the original owner in the event of a crash or any other non-warranty situation. Yeti Cycles does this at its sole discretion and reserves the right to refuse this offer.
- If you have a warranty concern, please contact your authorized Yeti dealer.

NO FAULT REPLACEMENT POLICY

Yeti Cycles will make replacement parts available at a minimum charge to the original owner in the event of a crash or any other non-warranty situation. Yeti Cycles does this at its sole discretion and reserves the right to refuse this offer. If you have a warranty concern, please contact your authorized Yeti dealer.

PRODUCT LIFE CYCLE

Every YETI frameset has a useful product life cycle. The length of that useful product life cycle will vary depending on the construction and the materials of the frameset, maintenance and care the frameset receives, and the amount and type of use the frameset is subjected to over its life. YETI recommends that an authorized YETI dealer should inspect the frame for stress annually. Frame stress could cause potential failure and the signs are usually apparent in the form of cracks, fracture lines, deformation, dents, and any other visual indicators of abnormality. These safety check for frame stress are important to prevent accidents, injury to the cyclist, and product failure of a YETI frameset.

DISCLAIMER

YETI Cycles is not responsible for any damages to you or others arising from riding, transporting or other use of your bicycle. In the event that your frame breaks or malfunctions, YETI Cycles shall have no liability or obligation beyond the repair or replacement of your frame pursuant to the terms outlined in the warranty.

CONTACT INFO

YETI Cycles
600 Corporate Circle, Unit D
Golden, CO 80401
(p) 303-278-6909
(f) 303-278-6906
WWW.YETICYCLES.COM

BUSINESS HOURS

Monday-Friday
8AM-11:30AM, 1:00PM-5:30PM
(Mountain Time)